

WORKING AT HEIGHT

TECHNICAL GUIDE



CONTENTS

Introduction	3
Legislation	4
Common Causes of Accidents	5
Best Practice	6
Working at Height - Hierarchy	8
Secondary Guarding	10
Telematics And Access Control	13
Personal Protective Equipment	14
EQSS Overwatch	15
Sunbelt Rentals Training Solutions	16
IPAF	18
PASMA	20
Low Level Access	22
Vertical Masts	34
Scissor Lifts	42
Boom Lifts	80
Tracked Access	114
Accessories	122
Primary Powered Access Depots	124
Rental Products and Managed Solutions	126

The equipment specifications in the guide are generic across a range of products and exact specifications may vary per model. Please contact our Hire Desk, Sales Team or refer to the OEM Operators Manuals should you require specific details.



Our Planet is our commitment.

A blueprint for a bright, sustainable future.

No ifs, buts, or maybes.

An action plan that is being actioned right now.

Sunbelt Rentals is leading from the front.

Investing in new low and zero carbon technologies today.

Driven by our commitment to reduce our carbon footprint by 2030.

Supporting local communities every day.

Creating jobs and investing in new skills.

To create positive change for generations to come.

Taking responsibility for our actions today and tomorrow.

Doing the right thing. Because it's the right thing to do.

For our customers, for our people.

For our communities, for our planet.

sunbeltrentals.co.uk/ourplanet

To help you identify our green and sustainable equipment we have created these symbols to highlight the key environmental benefits.



INTRODUCTION

Working at height remains one of the biggest causes of fatalities and major injuries. Common cases include falls from ladders and through fragile surfaces. Work at height means work in any place where a person could fall a distance likely to cause personal injury if there aren't any precautions in place.

It's important that employers and those in control of any working of height activity, ensure the correct work is planned, supervised and carried out by competent people. This includes using the right type of equipment for working at height.

At Sunbelt Rentals, we've got all the equipment you need for working at height safely. From Podiums and Alloy Towers to Low Level Access, Scissor Lifts and Boom Lifts.

You need it? We've got it.



LEGISLATION

Work at Height Regulations 2005

The purpose of the Work at Height Regulations 2005 (WAHR) is to prevent death and injury caused by a fall from height. The Regulations apply to you if you are an employer or you control work at height. This could include facilities managers or building owners who may contract others to work at height.

The first step is for employers and those in control to assess the risks first. Factors to weigh up include the height of the task, the duration and frequency. As well as the condition of the surface being worked on. There will also be low risk situations where Risk Assessment tells you no extra precautions are needed.

The law says you must make sure:

- all work at height is planned and organised
- those involved in work at height are competent
- the risks from work at height are assessed, and appropriate work equipment is used
- the risks of working on or near fragile surfaces are managed properly
- the equipment used for work at height is inspected and maintained

The Health & Safety Executive (HSE) has guidance online to help you comply with the Work at Height Regulations 2005.

Refer to www.hse.gov.uk/work-at-height/index.htm for more details.



COMMON CAUSES OF ACCIDENTS

Roof work can be high risk if not adequately managed. Especially falls from roofs and through fragile roofs and roof lights which are some of the most common causes of workplace death and serious injury.

These accidents can occur in the construction sector, as well as on the roofs of factories, warehouses and farm buildings when roof repair work or cleaning is being carried out.

BEST PRACTICE

How do you decide if someone is 'competent' to work at height?

Those working at height should have the relevant skills, knowledge and experience. If they're being trained, they should always work under the supervision of someone competent. If low risk, short duration (less than 30 minutes) tasks are being carried out using using low level access, it may simply be a case of making sure that employees receive instruction on how to use the equipment safely and appropriate training. Training often takes place on the job, it doesn't always take place in the classroom.

What can you do to protect people?

Always consider measures that protect everyone at risk (collective protection) before measures that only protect the individual (personal protection). Collective protection is equipment that doesn't require the person working at height to act to be effective, such as a guard rail. Personal protection is equipment that requires the individual to act to be effective. For example, putting on a safety harness correctly and connecting it to an anchor point with a lanyard.

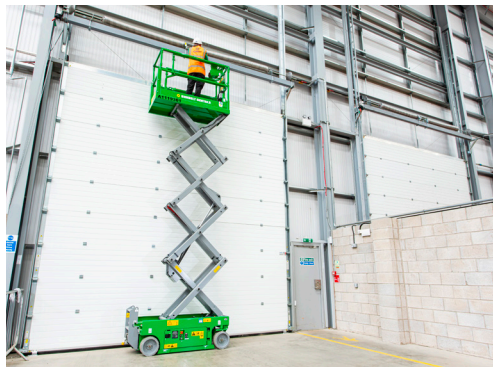

What do you need to consider when planning work at height?

Consider if bad weather conditions could compromise safety

- Check that the place where work at height is being undertaken is safe - every single time before work is carried out
- Stop materials or objects from falling. If it isn't practical to prevent objects falling, make sure that suitable measures are taken to avoid any injuries, such as exclusion zones
- Store materials and objects safely so they won't cause injury if they are disturbed or collapse
- Plan for emergencies and rescue

The hirer should always ensure that emergency recovery is adequately planned and recovery drills are regularly practiced.

How do you make sure equipment is in good condition?

Any equipment used for working at height must be assembled or installed according to the manufacturer's instructions and in keeping with industry guidelines. At Sunbelt Rentals, we inspect and maintain our equipment after every single hire. Making it as safe as it possibly can be.



WORKING AT HEIGHT REGULATIONS - HIERARCHY

Can you **AVOID** working at height in the first place?
If **NO**, go to **PREVENT**

Can you **PREVENT** a fall from occurring?
If **NO**, go to **MINIMISE**

Can you **MINIMISE** the distance and/or consequence of a fall?

Using ladders and stepladders

Do as much work as possible from the ground.

Some practical examples include:

- using extendable tools from ground level to remove the need to climb a ladder
- installing cables at ground level
- lowering a lighting mast to ground level
- ground level assembly of edge protection

You can do this by:

- using an existing place of work that is already safe, eg a non-fragile roof with a permanent perimeter guard rail or, if not
- using work equipment to prevent people from falling

Some practical examples of collective protection when using an existing place of work:

- a concrete flat roof with existing edge protection, or guarded mezzanine floor, or plant or machinery with fixed guard rails around it

Some practical examples of collective protection using work equipment to prevent a fall:

- mobile elevating work platforms (MEWPs) such as scissor lifts
- tower scaffolds
- scaffolds

An example of personal protection using work equipment to prevent a fall:

- using a work restraint (travel restriction) system that prevents a worker getting into a fall position

If the risk of a person falling remains, you must take sufficient measures to minimise the distance and/or consequences of a fall.

Practical examples of collective protection using work equipment to minimise the distance and consequences of a fall:

- safety nets and soft landing systems, eg air bags, installed close to the level of the work

An example of personal protection used to minimise the distance and consequences of a fall:

- individual rope access, eg working on a building façade
- fall-arrest system using a high anchor point

For tasks of low risk and short duration, ladders and stepladders can be a sensible and practical option.

If your risk assessment determines it is correct to use a ladder, you should further **MINIMISE** the risk by making sure workers:

- use the right type of ladder for the job
- are competent (you can provide adequate training and/or supervision to help)
- use the equipment provided safely and follow a safe system of work
- are fully aware of the risks and measures to help control them

Follow HSE guidance on safe use of ladders and stepladders at www.hse.gov.uk/work-at-height/index.htm

For each step, consider what is reasonably practicable and use 'collective protection' before 'personal protection'

SECONDARY GUARDING

Secondary Guarding products are designed to, (in most instances) stop the MEWP should the operator come in contact with an obstruction and the MEWP controls.

Once stopped the operator can reset if able, or if they are incapacitated ground personnel will be alerted via flashing beacon/s and audible alarm/s. In this scenario the ground controls can be used to rescue the operative.

Secondary guarding is available across our range of Booms. If you require it as standard please specify at time of hiring.





TELEMATICS AND ACCESS CONTROL

Access Control systems prevent the unauthorised use of MEWPs on site giving you, the hirer, peace of mind that your assets will be ready for work when needed. Access Control allows you to grant access for each operator via a PIN number or RFID card.

This process allows you to confirm the operator is trained and competent to use the asset before access is granted. This improves safety by reducing the risk of unauthorised use by untrained or unauthorised operatives. It also reduces the risk of theft.

The supporting telemetry system also delivers data directly into the site office via our Command Centre. In Command Centre you can manage your sustainability metrics, see the location of your assets and view reports on product utilisation giving you total control of your powered access fleet.

This product falls under our standard data protection governance, for more information please get in touch with your account manager.

Email: accesscontrol@sunbeltrentals.co.uk

PERSONAL PROTECTIVE EQUIPMENT

Sunbelt Rentals is committed to safety systems, policies, and procedures and that's why we provide appropriate PPE for every department. From head protection to safety footwear we strive to avoid incidents, injuries, and illnesses at all times.

By strictly following safety guidelines, operators contribute to a secure working environment. A safety-focused approach not only ensures compliance with regulations but also significantly minimises the risk of potential accidents and injuries. We're committed to supporting our customers with safe working at height which is why we provide a full range of personal protective equipment such as:

- Safety harnesses
- Lanyards
- Head protection
- Eye protections
- Hand protection
- Hi-Vis clothing
- Ear protection
- Safety footwear



EQSS OVERWATCH

The Overwatch system was specifically engineered to enhance safety for scissor lift operators by offering anti-entrapment protection. By employing a LIDAR sensor, OverWatch continuously monitors the operator's position and movements, synchronising this data with the machine's direction.

In the event of abrupt or unsafe movements, the system triggers an immediate halt to the scissor lift, mitigating potential risks. Notably, the system maintains an audit trail, recording crucial information through a secure WiFi link, ensuring comprehensive documentation for analysis and review. This innovative approach aims to provide a robust layer of protection and accountability in scissor lift operations.



SUNBELT RENTALS TRAINING SOLUTIONS

Sunbelt Rentals has over 80 years of equipment rental experience, where safety is our priority, and this deep cultural value is embedded within our world-class training delivery.

We offer a range of courses independently approved by the International Powered Access Federation (IPAF) and the Prefabricated Access Suppliers' and Manufacturers' Association (PASMA). We deliver training to thousands of individuals every year and we're proud to be an accredited IPAF and PASMA training provider. We have training centres all around the UK and we can also deliver training online or on site to suit your exact needs.

The courses on offer include:

- IPAF MEWPs Operator Training
- IPAF Harness Awareness, User, and Inspection
- IPAF Push Around Vertical (PAV)
- IPAF PAL+ Advanced Operator
- IPAF MEWPs for Managers
- PASMA Towers for Users
- PASMA Towers for Managers
- PASMA Low Level Access
- PASMA Work at Height

To book a course or to find out more information, give the Sunbelt Rentals Training team a call on 0300 373 3373, email trainingservices@sunbeltrentals.co.uk www.sunbeltrentals.co.uk

SUNBELT RENTALS



Approved
Training Centre



IPAF

IPAF promotes the safe and effective use of powered access equipment worldwide. Providing technical advice, influencing legislation, safety, and training.

IPAF has a number of training categories.



IPAF.org
Approved
Training Centre

To book a course or to find out more information:
Call: **0300 373 3373**
Email: trainingservices@sunbeltrentals.co.uk
www.sunbeltrentals.co.uk

IPAF.org

1a

1b

3a

3b

H

MCWP

PAV

IAD

GH

TPH

PH

MM

PAL
POWERED ACCESS LICENSE
THE MASTERSTROKE
SUNBELT RENTALS
TRAINING SERVICES
IPAF

www.ipaf.org

TR-672-0419-3

TOWERS AND PLATFORMS

We also offer a range of access equipment to help you work safely at height.

Our range of Towers and Podiums are perfect for essential repairs, maintenance and installation tasks where you need safe and simple low level access.

Our Podiums are easy to assemble by just one person and enable you to safely complete work at a range of heights up to 3.3m.

Our Pop-up Towers are easy to manoeuvre and require no assembly, enabling the user to quickly reach heights of over 3m.



PASMA

Founded in 1974, the Prefabricated Access Suppliers' and Manufacturers' Association (PASMA), is the recognised focus and authority for mobile access towers.

The association governs the industry-standard training for mobile access towers, ensuring compliance with Work at Height Regulations. The PASMA certificate and ID card serve as essential proof of competence. Furthermore, it plays a crucial role in shaping and advancing standards for the construction, use, inspection, and maintenance of mobile access towers.



LOW LEVEL ACCESS

From Self-Propelled Powered Access to Push-Around Vertical (PAV) solutions that do not require a power source, our range of Low Level Access equipment offers accessible, safe and efficient solutions to minimise the risks associated with working at height.



PECO LIFT

Working Height 3.5m

Make	JLG	Closed Length	0.98m
Model	Peco Lift	Platform Area	0.72m x 0.60m
Working Height	3.5m	Safe Working Load	150kg
Platform Height	1.5m	Weight	180kg
Width	0.7m	Power Source	Manual
Closed Height	1.55m		

- Push Around Vertical
- Battery free, power free, oil free
- Simply turn handle to elevate
- Indoor only



IQ LIFT PRO 7 ACTIVE

Working Height 4.1m

Make	Pop-Up Products	Closed Length	1.2m
Model	IQ Lift	Platform Area	0.68m x 0.59m
Working Height	4.1m	Safe Working Load	125kg
Platform Height	2.1m	Weight	274kg
Width	0.7m	Power Source	Manual
Closed Height	1.68m		

- Lightweight and manoeuvrable
- Low entry into platform
- Quick and smooth elevation
- Battery free, hydraulics free

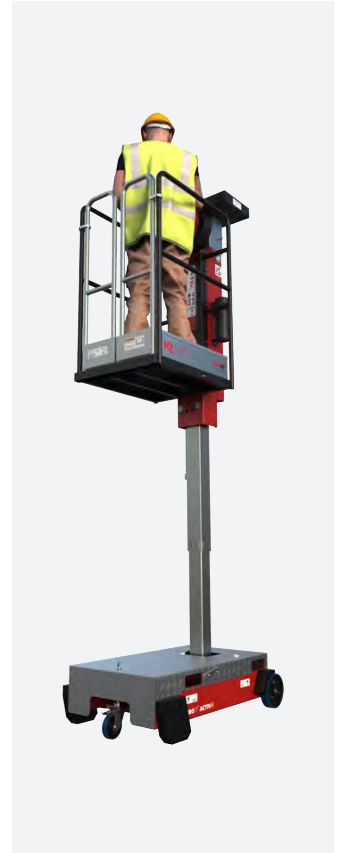

ECO LIFT Working Height 4.2m

Make	JLG	Closed Length	1.28m
Model	Eco Lift	Platform Area	0.85m x 0.64m
Working Height	4.2m	Safe Working Load	150kg
Platform Height	2.2m	Weight	305kg
Width	0.74m	Power Source	Manual
Closed Height	1.95m		

- Push Around Vertical
- Battery free, power free, oil free
- Simply turn handle to elevate
- Indoor only



PUSH 8 PRO Working Height 4.43m

Make	Pop-Up	Closed Length	1.23m
Model	Push 8 Pro	Platform Area	0.51m x 1.09m
Working Height	4.43m	Safe Working Load	240kg
Platform Height	2.43m	Weight	331kg
Width	0.76m	Power Source	Electric
Closed Height	1.67m		

- Push Around Vertical
- Indoor only
- Emergency lowering lever
- Lightweight and compact

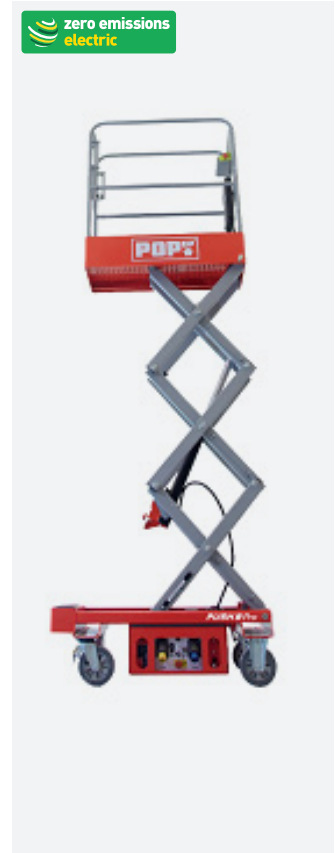

POP-UP+ Working Height 4.5m

Make	Pop-Up Products	Closed Length	1.2m
Model	Pop-Up+	Platform Area	1.01m x 0.52m
Working Height	4.5m	Safe Working Load	240kg
Platform Height	2.5m	Weight	343kg
Width	0.7m	Power Source	Electric
Closed Height	1.8m		

- Push Around Vertical
- Easy to manoeuvre
- Indoor only



NANO Working Height 4.5m

Make	JLG	Closed Length	1.2m
Model	Nano	Platform Area	1m x 0.73m
Working Height	4.5m	Safe Working Load	200kg
Platform Height	2.5m	Weight	285kg
Width	0.75m	Power Source	Electric
Closed Height	1.56m		

- Push Around Vertical
- Indoor only
- Easy to manoeuvre



NANO SP/NANO SP+ Working Height 4.5m

Make	JLG	Platform Area	1m x 0.73m
Model	Nano SP	Deck Extension	SP 0.5m/ SP+ 1m
Working Height	4.5m	Safe Working Load	200kg
Platform Height	2.5m	Weight	SP 500kg/ SP+ 540kg
Width	0.75m	Power Source	Electric
Closed Height	1.59m		
Closed Length	1.22m		

- Self Propelled
- 1.195m x 0.75m working footprint
- Wind rated
- The Nano SP+ provides extra deck extension



PRO 10 IQ Working Height 5m

Make	Pop-Up Products	Closed Length	1.2m
Model	Pro 10 IQ	Platform Area	1.04m x 0.52m
Working Height	5m	Safe Working Load	240kg
Platform Height	3m	Weight	394kg
Width	0.76m	Power Source	Electric
Closed Height	1.8m		

- Push Around Vertical
- Indoor only
- Passes through a standard doorway



POWER TOWER Working Height 5.1m

Make	JLG	Closed Length	1.6m
Model	Power Tower	Platform Area	1.52 x 0.75m
Working Height	5.1m	Safe Working Load	250kg
Platform Height	3.1m	Weight	312kg
Width	0.78m	Power Source	Electric
Closed Height	1.85m		

- Push Around Vertical
- Passes through single doorways
- Large 1m x 0.73m platform size gives the user more room to work
- Indoor use



Dingli 0607A Working Height 5.9m

Make	Dingli	Closed Length	1.2m
Model	0607A	Platform Area	1.04m x 0.52m
Working Height	5.9m	Safe Working Load	240kg
Platform Height	3.9m	Weight	530kg
Width	0.76m	Power Source	Electric
Closed Height	1.8m		

- Push Around Vertical
- Indoor only
- Passes through a standard doorway



VERTICAL MASTS

Vertical Masts are an ideal elevated working platform solution, suited to confined spaces with reach capabilities of up to 12m (39ft).



AMWP7 - 8100L Working Height 6.7m

Make	Dingli	Platform Area	1m x 0.76m
Model	AM1P7-8100L	Deck Extension	0.5m
Working Height	6.7m	Safe Working Load	200kg
Platform Height	4.7m	Weight	990kg
Width	0.76m	Power Source	Electric
Closed Height	1.99m		
Closed Length	1.45m		

- Indoor only
- Oil Free

IPAF License 3A



SJ16

Working Height 6.75m

- Indoor only
- A low weight compact electric self propelled mast lift

Make	Skyjack	Platform Area	0.69m x 0.93m
Model	SJ16	Deck Extension	0.51m
Working Height	6.75m	Safe Working Load	227kg
Platform Height	4.75m	Weight	966kg
Width	0.76m	Power Source	Electric
Closed Height	1.79m		
Closed Length	1.37m		

Alternative Machines Dingli AMWP7-8100L

IPAF License 3A



STAR10

Working Height 10m

Make	Haulotte	Platform Area	0.98m x 0.78m
Model	Star10	Safe Working Load	200kg
Working Height	10m	Weight	2760kg
Platform Height	8m	Power Source	Electric
Working Outreach	3m		
Width	1m		
Closed Height	1.99m		
Closed Length	2.7m		

Alternative Machine E33MJ / Toucan 10

IPAF License 3B



- Narrow width
- Jib for outreach
- Zero tail-swing

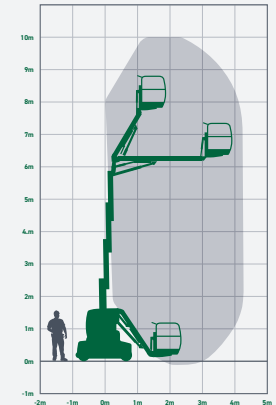

Toucan 10

Working Height 10.1m

Make	JLG	Platform Area	0.7m x 0.9m
Model	Toucan 10E	Deck Extension	3.38m
Working Height	10.05m	Safe Working Load	226kg
Platform Height	8.05m	Weight	3129kg
Width	0.99m	Power Source	Electric
Closed Height	1.96m		
Closed Length	2.82m		

Alternative Machine Star 10 & Toucan 12

IPAF License 3B

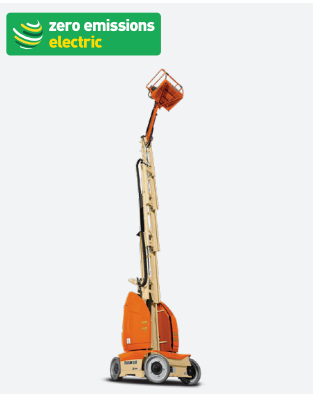

- Narrow width
- Jib for outreach
- AC Power cable to platform

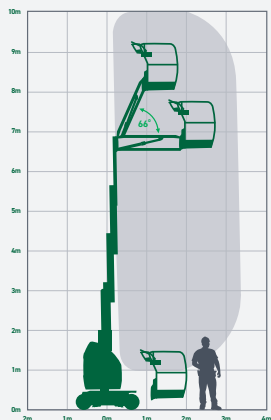

E33MJ

Working Height 11.98m

Make	JLG	Platform Area	1.1m x 0.7m
Model	E33MJ	Safe Working Load	227kg
Working Height	11.98m	Weight	5250kg
Platform Height	9.98m	Power Source	Electric
Working Outreach	4.42m		
Width	1.2m		
Closed Height	1.99m		
Closed Length	3.85m		

Alternative Machines Star10 / Toucan 12

IPAF License 3B



- Narrow width
- Jib for outreach
- Zero tail-swing

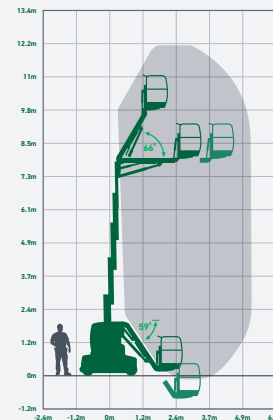

Toucan 12E Plus

Working Height 12.75m

Make	JLG	Platform Area	1.05m x 0.7m
Model	Toucan 12E Plus	Safe Working Load	200kg
Working Height	12.65m	Weight	4900kg
Platform Height	10.65m	Power Source	Electric
Working Outreach	6.05m		
Width	1.2m		
Closed Height	1.99m		
Closed Length	3.65m		

Alternative Machine HR12N

IPAF License 3B



- Narrow width
- Jib for outreach
- Slide bar rear entry

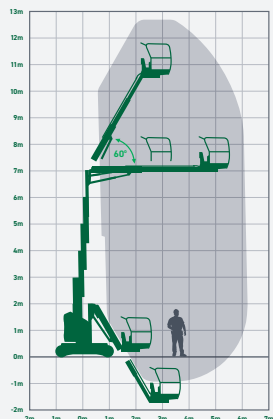



SCISSOR LIFTS

We have an extensive hire fleet of scissor lifts, offering reach capabilities from 7m to 21.5m. With diesel, bi-fuel and electric options, there is a range of safe access solutions for all indoor and outdoor work areas.

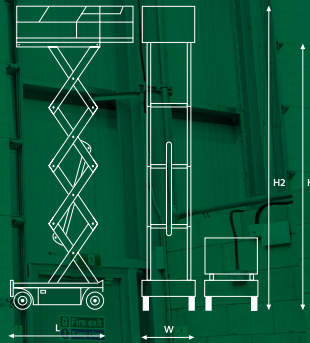

GS-1932

Working Height 7.8m

Make	Genie	Platform Area	0.74m x 1.63m
Model	GS-1932	Deck Extension	0.94m
Working Height	7.8m	Safe Working Load	227kg
Platform Height	5.8m	Weight	1503kg
Width	0.81m	Power Source	Electric
Closed Height	2.11m		
Handrails Down	1.75m		
Closed Length	1.83m		

Alternative Machines 1930ES / S1930 / SJ3219 / 0807AC / JLG6RS

IPAF License 3A



- Solid Non Marking Tyres
- Extending Deck
- Pothole Protection

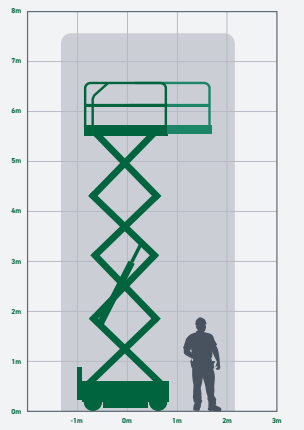

S1930E

Working Height 7.71m

Make	JCB	Platform Area	1.64m x 0.77m
Model	S1930E	Deck Extension	0.9m
Working Height	7.71m	Safe Working Load	230kg
Platform Height	5.71m	Weight	1696kg
Width	0.77m	Power Source	Electric
Closed Height	2.12m		
Handrails Down	1.85m		
Closed Length	1.78m		

Alternative Machines S1930 / GS1932 / SJ3219 / 0807AC / JLG6RS

IPAF License 3A



- Solid Non Marking Tyres
- Extending Deck
- Pothole Protection

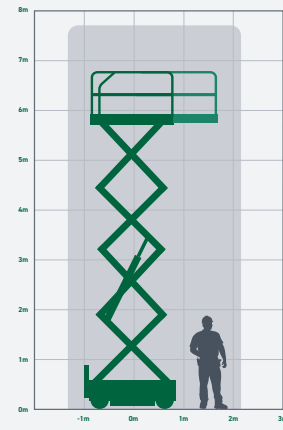

1930ES Working Height 7.72m

Make	JLG	Platform Area	1.59m x 0.64m
Model	1930ES	Deck Extension	0.91m
Working Height	7.72m	Safe Working Load	230kg
Platform Height	5.72m	Weight	1506kg
Width	0.76m	Power Source	Electric
Closed Height	2.02m		
Handrails Down	1.59m		
Closed Length	1.87m		

Alternative Machines SJ3219 / GS1932 / 0807AC / S1930E / JLG6RS

IPAF License 3A



- Solid Non Marking Tyres
- Extending Deck
- Pothole Protection

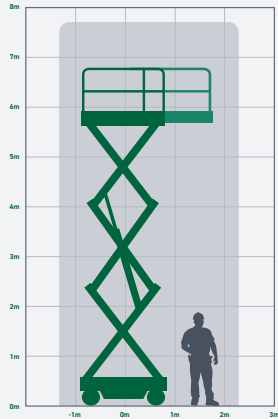

SJ3219 Working Height 7.79m

Make	Skyjack	Platform Area	1.63m x 0.66m
Model	SJ3219	Deck Extension	0.91m
Working Height	7.79m	Safe Working Load	249kg
Platform Height	5.79m	Weight	1170kg
Width	0.81m	Power Source	Electric
Closed Height	1.99m		
Handrails Down	1.64m		
Closed Length	1.78m		

Alternative Machines 1930E / GS1932 / 1932ES / 6RS / 0807AC

IPAF License 3A



- Solid Non Marking Tyres
- Extending Deck
- Pothole Protection

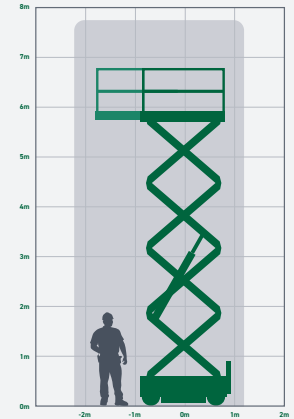

JLG 6RS Working Height 7.79m

Make	JLG	Platform Area	1.82m x 0.69m
Model	6RS	Deck Extension	0.71m
Working Height	7.79m	Safe Working Load	230kg
Platform Height	5.79m	Weight	1565kg
Width	0.81m	Power Source	Electric
Closed Height	2.02m		
Handrails Down	1.76m		
Closed Length	2.07m		

Alternative Machines 1930E / GS1932 / 1932ES / SJ3219 / 0807AC

IPAF License 3A



- Solid Non Marking Tyres
- Extending Deck
- Pothole Protection

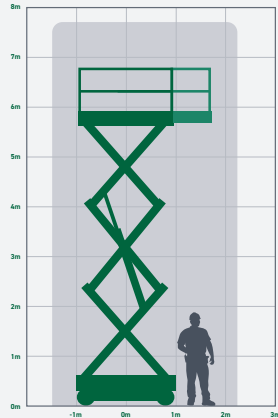

0807 AC Working Height 7.8m

Make	Dingli	Platform Area	1.67m x 0.74m
Model	0807 AC	Deck Extension	0.9m
Working Height	7.8m	Safe Working Load	230kg
Platform Height	5.8m	Weight	1630kg
Width	0.76m	Power Source	Electric
Closed Height	2.15m		
Handrails Down	1.83m		
Closed Length	1.86m		

Alternative Machines 1930E / GS1932 / 1932ES / SJ3219 / JLG6RS

IPAF License 3A



- Extending Deck
- Rough Terrain
- Self-levelling Outriggers
- All Electric

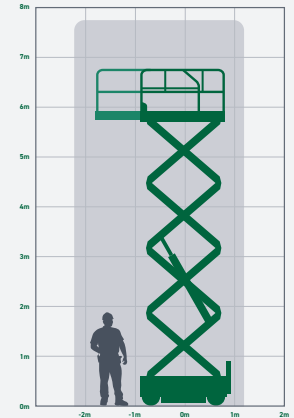

2630ES

Working Height 9.75m

Make	JLG	Platform Area	2.3m x 0.76m
Model	2630ES	Deck Extension	0.91m
Working Height	9.75m	Safe Working Load	227kg
Platform Height	7.75m	Weight	2200kg
Width	0.76m	Power Source	Electric
Closed Height	2.33m		
Handrails Down	1.94m		
Closed Length	2.3m		

Alternative Machines SJ3226 / GS2632 / 1008AC / S2632E

IPAF License 3A



- Solid Non Marking Tyres
- Extending Deck
- Pothole Protection
- Indoor use only

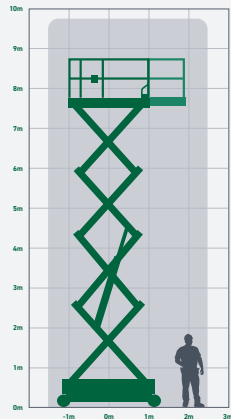

SJ6826 RT

Working Height 9.75m

Make	Skyjack	Platform Area	2.44m x 1.42m
Model	SJ6826 RT	Deck Extension	1.5m
Working Height	9.75m	Safe Working Load	431kg
Platform Height	7.75m	Weight	2930kg
Width	1.76m	Power Source	Diesel
Closed Height	2.38m		
Handrails Down	1.61m		
Closed Length	2.72m		

Alternative Machines GS26D / SJ6832RT

IPAF License 3A



- Extending Deck
- Rough Terrain
- Self-levelling Outriggers

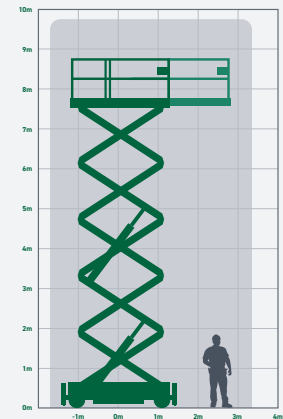

S2632E

Working Height 9.92m

Make	JCB	Platform Area	2.25m x 0.81m
Model	S2632E	Deck Extension	0.9m
Working Height	9.92m	Safe Working Load	250kg
Platform Height	7.92m	Weight	2180kg
Width	0.83m	Power Source	Electric
Closed Height	2.33m		
Handrails Down	1.96m		
Closed Length	2.39m		

Alternative Machines SJ3226 / 2630ES / 1008AC / S2632E

IPAF License 3A



- Solid Non Marking Tyres
- Extending Deck
- Pothole Protection
- Indoor use only

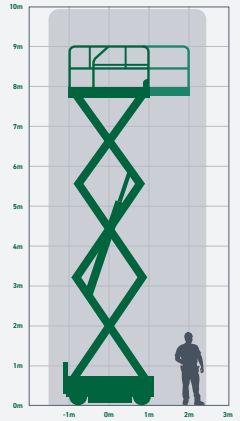

1008 AC

Working Height 9.92m

Make	Dingli	Platform Area	2.27m x 0.81m
Model	1008 AC	Deck Extension	0.9m
Working Height	10m	Safe Working Load	230kg
Platform Height	8m	Weight	2190kg
Width	0.83m	Power Source	Electric
Closed Height	2.36m		
Handrails Down	2m		
Closed Length	2.48m		

Alternative Machine S2632E / 2630ES

IPAF License 3A

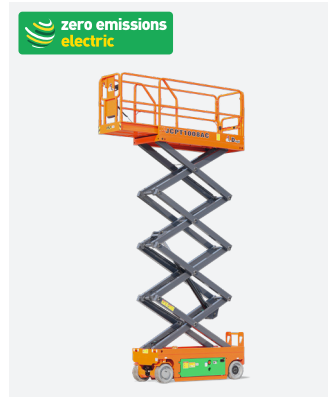

- Extending Deck
- All Electric
- Indoor use only

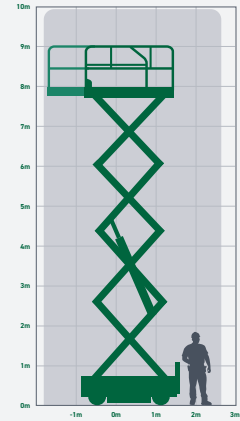

SJ6832 RT & RTE

Working Height 11.75m

Make	Skyjack	Platform Area	2.44m x 1.42m
Model	SJ6832 RT	Deck Extension	1.52m
Working Height	11.75m	Safe Working Load	454kg
Platform Height	9.75m	Weight	RT 3443kg/ RTE 3577kg
Width	1.76m	Power Source	RT Diesel/ RTE Hybrid
Closed Height	2.51m		
Handrails Down	1.75m		
Closed Length	2.72m		

Alternative Machines ES32 / ES3369RT / GS3369RT

IPAF License 3A



- The SJ6832 RTE is a Hybrid unit with 3 Power settings:
On – Diesel only
Auto – Automatically switches to diesel when battery drops low
Off – Electric only
- The SJ6832 RT is a Diesel only model
- Extending Deck
- Rough Terrain
- Self-levelling Outriggers

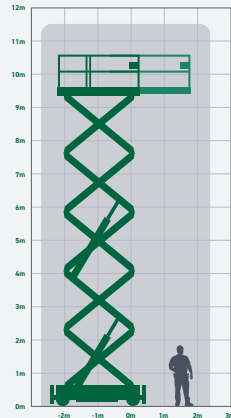

3246ES

Working Height 11.68m

Make	JLG	Platform Area	2.5m x 0.92m
Model	3246ES	Deck Extension	0.9m
Working Height	11.68m	Safe Working Load	318kg
Platform Height	9.68m	Weight	2257kg
Width	1.17m	Power Source	Electric
Closed Height	2.36m		
Handrails Down	1.97m		
Closed Length	2.5m		

Alternative Machines SJ4632 / GS3246

IPAF License 3A



- Solid Non Marking Tyres
- Extending Deck
- Pothole Protection

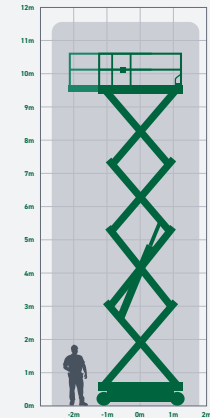

3246E Working Height 11.7m

Make	JCB	Platform Area	2.25m x 1.17m
Model	3246E	Deck Extension	0.9m
Working Height	11.7m	Safe Working Load	320kg
Platform Height	9.7m	Weight	2866kg
Width	1.18m	Power Source	Electric
Closed Height	2.48m		
Handrails Down	1.86m		
Closed Length	2.39m		

Alternative Machines SJ4632 / GS3246 / 3246ES

IPAF License 3A



- Extending Deck
- All Electric
- Solid Non Marking Tyres
- Pothole Protection

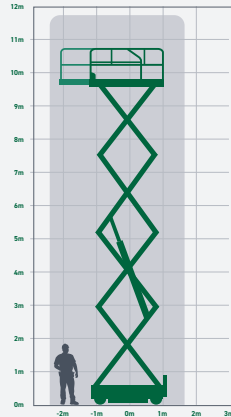

SJIII 4632 Working Height 11.75m

Make	Skyjack	Platform Area	2.13m x 1.07m
Model	SJIII 4632	Deck Extension	1.22m
Working Height	11.75m	Safe Working Load	318kg
Platform Height	9.75m	Weight	2302kg
Width	1.17m	Power Source	Electric
Closed Height	2.24m		
Handrails Down	1.88m		
Closed Length	2.31m		

Alternative Machines GS3246 / GS4047

IPAF License 3A



- Solid Non Marking Tyres
- Extending Deck
- Pothole Protection

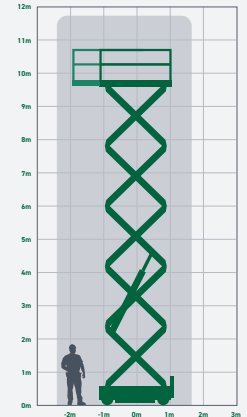

GS-3246 Working Height 11.75m

Make	Genie	Platform Area	2.26m x 1.15m
Model	GS-3246	Deck Extension	0.91m
Working Height	11.75m	Safe Working Load	318kg
Platform Height	9.75m	Weight	2796kg
Width	1.17m	Power Source	Electric
Closed Height	2.3m		
Handrails Down	1.8m		
Closed Length	2.43m		

Alternative Machines SJ4632 / GS4047

IPAF License 3A



- Solid Non Marking Tyres
- Extending Deck
- Pothole Protection

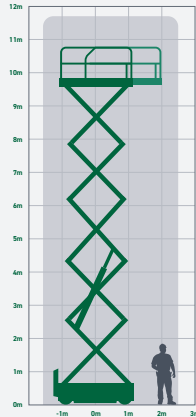

GS-3369 RT Working Height 11.9m

Make	Genie	Platform Area	2.79m x 1.6m
Model	GS-3369 RT	Deck Extension	1.52m
Working Height	11.9m	Safe Working Load	454kg
Platform Height	9.9m	Weight	3949kg
Width	1.75m	Power Source	Diesel
Closed Height	2.59m		
Handrails Down	1.92m		
Closed Length	3.12m		

Alternative Machine GS3390RT

IPAF License 3A

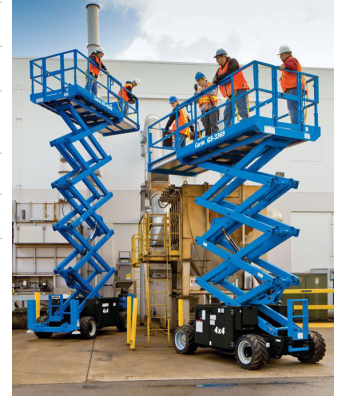

- Extending Deck
- Rough Terrain
- Self-levelling Outriggers

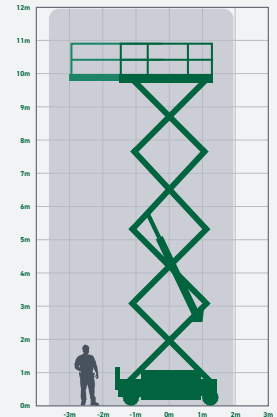

1212 AC Working Height 12m

Make	Dingli	Platform Area	2.27m x 1.12m
Model	1212 AC	Deck Extension	0.9m
Working Height	12m	Safe Working Load	320kg
Platform Height	10m	Weight	3060kg
Width	1.15m	Power Source	Electric
Closed Height	2.49m		
Handrails Down	1.96m		
Closed Length	2.48m		

Alternative Machines GS4047 / S4046E

IPAF License 3A



- Extending Deck
- All Electric
- Pothole Protection

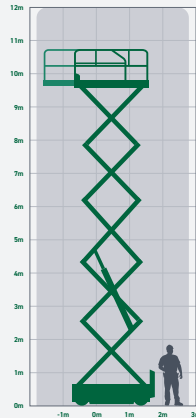

GS-3390 RT Working Height 11.9m

Make	Genie	Platform Area	5.34m x 1.83m
Model	GS-3390 RT	Deck Extension (Dual)	2.74m
Working Height	12.06m	Safe Working Load	1134kg
Platform Height	10.06m	Weight	6890kg
Width	2.29m	Power Source	Diesel
Closed Height	2.71m		
Handrails Down	2.03m		
Closed Length	4.88m		

Alternative Machines GS3369RT / GS4390RT / SJ8841RT / SJ9241RT

IPAF License 3A

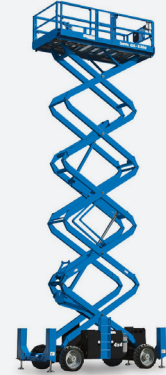

- Dual Extending Decks
- Rough Terrain
- Self-levelling Outriggers

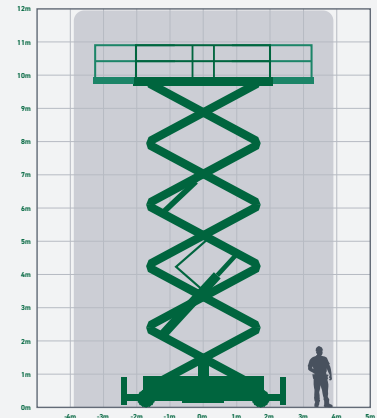

GS-4047 Working Height 13.89m

Make	Genie	Platform Area	2.26m x 1.16m
Model	GS-4047	Deck Extension	0.91m
Working Height	13.7m	Safe Working Load	350kg
Platform Height	11.7m	Weight	3260kg
Width	1.19m	Power Source	Electric
Closed Height	2.54m		
Handrails Down	1.95m		
Closed Length	2.48m		

Alternative Machine S4046

IPAF License 3A



- Solid Non Marking Tyres
- Extending Deck
- Pothole Protection
- Indoor Use Only

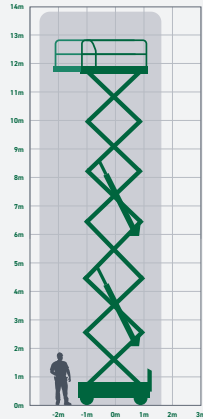

S4046E Working Height 13.9m

Make	JCB	Platform Area	2.25m x 1.15m
Model	S4046E	Deck Extension	0.9m
Working Height	13.9m	Safe Working Load	320kg
Platform Height	11.9m	Weight	3070kg
Width	1.18m	Power Source	Electric
Closed Height	2.6m		
Handrails Down	1.98m		
Closed Length	2.39m		

Alternative Machines GS4047 / M4069

IPAF License 3A



- Solid Non Marking Tyres
- Extending Deck
- Pothole Protection
- Indoor Use Only

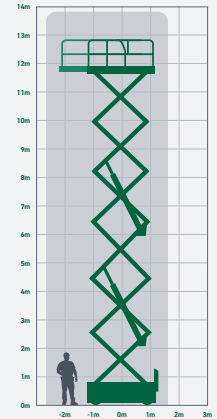

M4069 / 4069LE Working Height 14.19m

Make	JLG	Platform Area	2.92m x 1.65m
Model	M4069	Deck Extension	0.91m
Working Height	14.19m	Safe Working Load	360kg
Platform Height	12.19m	Weight	5700kg
Width	1.75m	Power Source	4069 LE Electric/ M4069 Hybrid
Closed Height	2.83m		
Handrails Down	2.04m		
Closed Length	3.07m		

Alternative Machines GS4047 / S4046E

IPAF License 3A

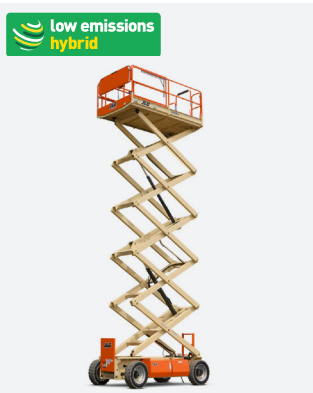

- Solid Non Marking Tyres
- Extending Deck

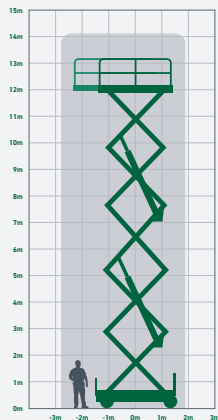

JCPT1418 RT Working Height 14.30m

Make	Dingli	Closed Length	3.84m
Model	JCPT1418 RT	Platform Area	2.88m x 1.52m
Working Height	14.30m	Deck Extension	1.43m
Platform Height	12.30m	Safe Working Load	363kg
Width	1.76m	Weight	5050kg
Closed Height	2.74m	Power Source	Diesel
Handrails Down	1.97m		

Alternative Machines JCPT1418 DC

IPAF License 3A



- Extending Deck
- Rough Terrain
- Self-levelling Outriggers

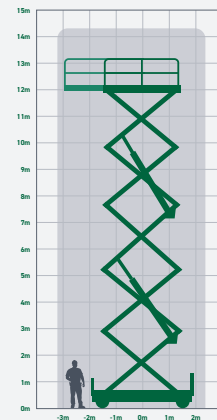

JCPT1418 DC Working Height 14.30m

Make	Dingli	Platform Area	2.88m x 1.52m
Model	JCPT1418 DC	Deck Extension	1.43m
Working Height	14.30m	Safe Working Load	363kg
Platform Height	12.30m	Weight	5150kg
Width	1.76m	Power Source	Electric
Closed Height	2.74m		
Handrails Down	1.97m		
Closed Length	3.84m		

Alternative Machines JCPT1418 RT

IPAF License 3A



- Extending Deck
- Rough Terrain
- Self-levelling Outriggers
- All Electric

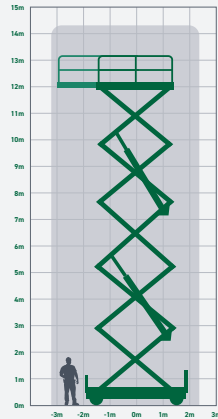

SJ8841 RT Working Height 14.32m

Make	Skyjack	Platform Area	3.4m x 1.7m
Model	SJ8841 RT	Deck Extension (Dual)	2.44m
Working Height	14.32m	Safe Working Load	680kg
Platform Height	12.32m	Weight	4935kg
Width	2.21m	Power Source	Diesel
Closed Height	2.9m		
Handrails Down	2.22m		
Closed Length	3.53m		

Alternative Machines SJ9241RT / GS4390 / SJ9250RT / GS5390RT

IPAF License 3A



- Dual Extending Decks
- Rough Terrain
- Self-levelling Outriggers

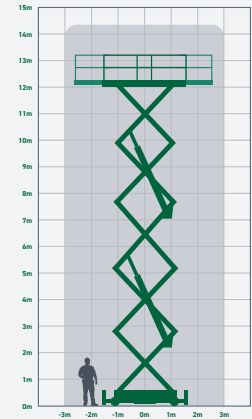

SJ9241 RT Working Height 14.5m

Make	Skyjack	Platform Area	4.21m x 1.88m
Model	SJ9241 RT	Deck Extension (Dual)	3.06m
Working Height	14.5m	Safe Working Load	681kg
Platform Height	12.5m	Weight	6715kg
Width	2.34m	Power Source	Diesel
Closed Height	2.84m		
Handrails Down	1.98m		
Closed Length	4.47m		

Alternative Machines SJ8841 / SJ9250

IPAF License 3A



- Dual Extending Decks
- Rough Terrain
- Self-levelling Outriggers

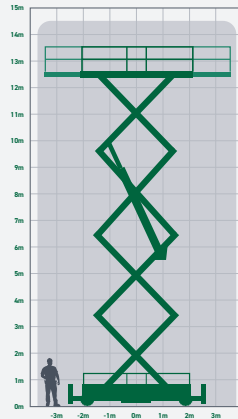

GS-4390 RT Working Height 14.75m

Make	Genie	Platform Area	3.98m x 1.83m
Model	GS-4390 RT	Deck Extension (Dual)	3.37m
Working Height	15.11m	Safe Working Load	680kg
Platform Height	13.11m	Weight	7323kg
Width	2.34m	Power Source	Diesel
Closed Height	2.93m		
Handrails Down	2.25m		
Closed Length	4.88m		

Alternative Machines SJ9250RT / GS5390RT

IPAF License 3A



- Dual Extending Decks
- Rough Terrain
- Self-levelling Outriggers

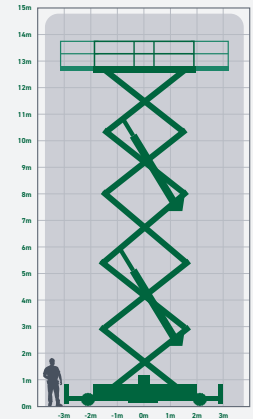

JCPT1612 DC Working Height 15.7m

Make	Dingli	Platform Area	2.64m x 1.12m
Model	JCPT1612 DC	Deck Extension	0.9m
Working Height	15.7m	Safe Working Load	250kg
Platform Height	13.7m	Weight	3360kg
Width	1.25m	Power Source	Electric
Closed Height	2.62m		
Handrails Down	2.09m		
Closed Length	2.84m		

Alternative Machines S4550E

IPAF License 3A



S4550E Working Height 15.8m

Make	JCB	Platform Area	2.25m x 0.81m
Model	S4550E	Deck Extension	0.9m
Working Height	15.8m	Safe Working Load	227kg
Platform Height	13.8m	Weight	3366kg
Width	1.25m	Power Source	Electric
Closed Height	2.6m		
Handrails Down	2.2m		
Closed Length	2.76m		

Alternative Machines JCPT1612 DC

IPAF License 3A



- Extending Deck
- All Electric
- Indoor Use Only
- Pothole Protection

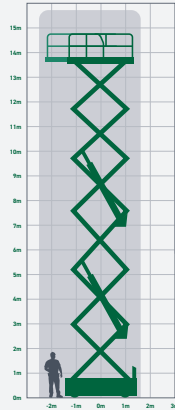

- Solid Non Marking Tyres
- Extending Deck
- Pothole Protection
- Indoor Use Only

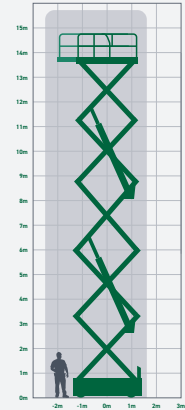

GS4655

Working Height 15.95m

Make	Genie	Handrails Down	1.98m
Model	GS4655	Closed Length	3.11m
Indoor Working Height	15.95m	Platform Area	2.84m x 1.35m
Outdoor Working Height	8.55m	Deck Extension (Dual)	1.22m
Indoor Platform Height	13.95m	Safe Working Load	350kg
Outdoor Platform Height	6.55m	Weight	3701kg
Width	1.4m	Power Source	Electric
Closed Height	2.77m		

Alternative Machines S4550E

IPAF License 3A



- Extending Deck
- All Electric
- Indoor and Outdoor Use

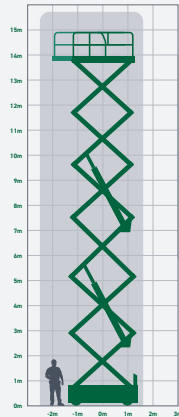

SJ9250 RT

Working Height 17.2m

Make	Skyjack	Platform Area	4.27m x 1.88m
Model	SJ9250 RT	Deck Extension (Dual)	3.04m
Working Height	17.2m	Safe Working Load	680kg
Platform Height	15.2m	Weight	6895kg
Width	2.34m	Power Source	Diesel
Closed Height	3.17m		
Handrails Down	2.29m		
Closed Length	4.47m		

Alternative Machine GS5390RT

IPAF License 3A



- Dual Extending Decks
- Rough Terrain
- Self-levelling Outriggers

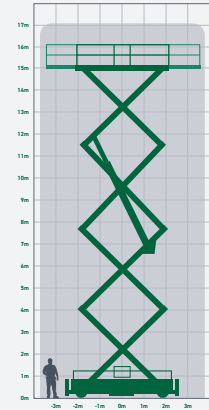

JCPT1823 RTB Working Height 18m

Make	Dingli	Platform Area	3.98m x 1.83m
Model	JCPT1823 RTB	Deck Extension (Dual)	2.59m
Working Height	18m	Safe Working Load	680kg
Platform Height	16m	Gross Weight	8590kg
Width	2.27m	Power Source	Diesel
Closed Height	3.19m		
Handrails Down	2.49m		
Closed Length	4.88m		

Alternative Machine GS5390RT

IPAF License 3A



- Dual Extending Decks
- Rough Terrain
- Self-levelling Outriggers

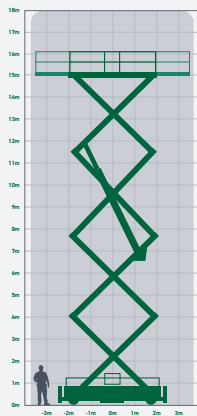

HS18 E PRO Working Height 18m

Make	Haulotte	Platform Area	3.93m x 1.89m
Model	HS18 E PRO	Deck Extension (Dual)	0.98m
Working Height	18m	Safe Working Load	750kg
Platform Height	16m	Weight	8048kg
Width	2.3m	Power Source	Electric
Closed Height	3.15m		
Handrails Down	2.36m		
Closed Length	4.4m		

Alternative Machine JCPT1823 RTB

IPAF License 3A

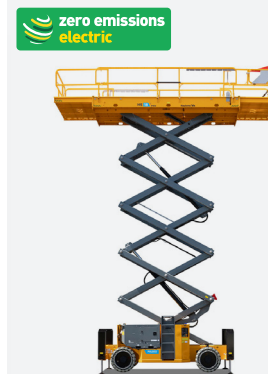

- Dual Extending Decks
- Rough Terrain
- Self-levelling Outriggers

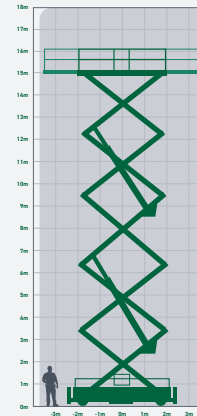

GS5390 RT Working Height 18.15m

Make	Genie	Platform Area	3.98m x 1.83m
Model	GS5390 RT	Deck Extension (Dual)	3.38m
Working Height	18.15m	Safe Working Load	680kg
Platform Height	16.15m	Gross Weight	7515kg
Width	2.34m	Power Source	Diesel
Closed Height	3.15m		
Handrails Down	2.47m		
Closed Length	4.88m		

Alternative Machine JCPT1823 RTB

IPAF License 3A



- Dual Extending Decks
- Rough Terrain
- Self-levelling Outriggers

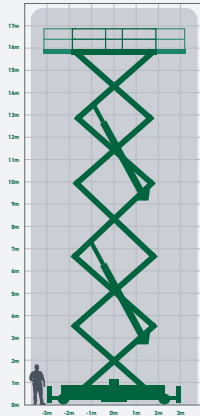

SJ9664 RT Working Height 21.51m

Make	Skyjack	Platform Size	4.36m x 1.90m
Model	SJ9664 RT	Deck Extension (Dual)	3.04m
Working Height	21.51m	Safe Working Load	513kg
Platform Height	19.51m	Weight	9997kg
Width	2.44m	Power Source	Diesel
Closed Height	3.61m		
Handrails Down	2.77m		
Closed Length	4.57m		

Alternative Machine JCPT2223 DC

IPAF License 3A



- Dual Extending Decks
- Rough Terrain
- Self-levelling Outriggers

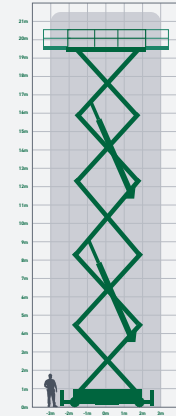

JCPT2223 DC Working Height 22m

Alternative Machine SJ9664 RT

IPAF License 3A

Make	Dingli	Closed Length	4.95m
Model	JCPT2223 DC	Platform Size	4.59m x 2.25m
Working Height	22m	Deck Extension	2.70m
Platform Height	20m	Safe Working Load	750kg
Width	2.46m	Weight	13400kg
Closed Height	3.86m	Power Source	Electric
Handrails Down	3m		



- Extending Deck
- Rough Terrain
- Self-levelling Outriggers
- All Electric

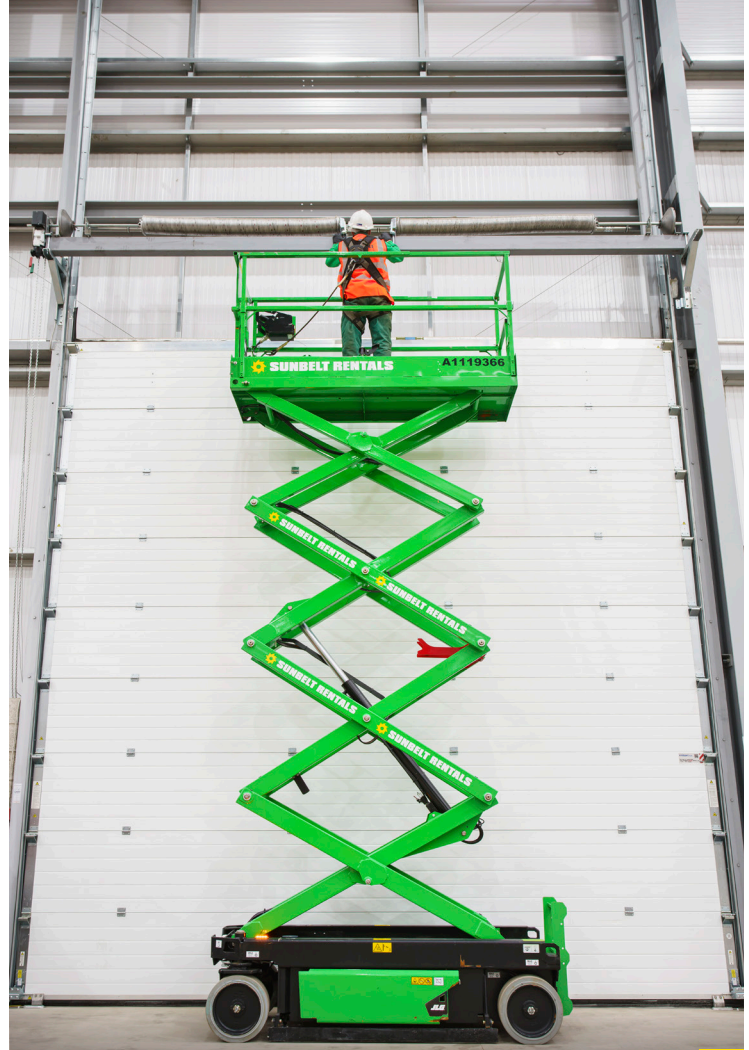
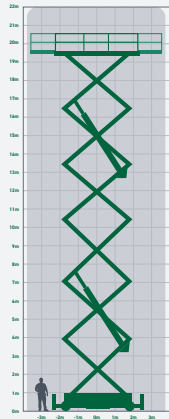



BOOM LIFTS

Our range of **Articulating Booms** enable you to access hard to reach areas and reach over or around obstructions. Articulating Booms can be hired in a range of sizes and specifications to suit the work being undertaken, providing a maximum working height of 43.15m and a maximum outreach of 21.26m. The articulating jib provides increased flexibility when positioning the platform to help you undertake a range of tasks at height. You can choose from electric, diesel and hybrid (Bi-Energy) powered booms, suitable for a range of indoor and outdoor environments.

Our **Telescopic Booms** are available in a range of sizes, allowing a reach of up to 43.3m and an outreach of up to 24.38m. You can choose from electric, diesel and hybrid (Bi-Energy) powered booms, suitable for a range of indoor and outdoor environments. Available to hire from our National network of Powered Access Depots, our products are at the forefront of technology.



Z-30/20N RJ Working Height 10.89m

Make	Genie	Platform Area	1.17m x 0.76m
Model	Z-30	Safe Working Load	227kg
Working Height	10.89m	Weight	6605kg
Platform Height	8.89m	Power Source	Electric
Working Outreach	6.25m		
Width	1.19m		
Closed Height	2m		
Closed Length	5.31m		

Alternative Machines E300AJP / HR12N

IPAF License 3B

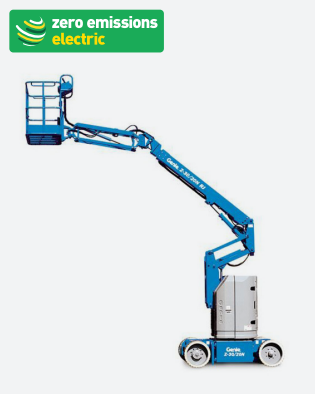

- Narrow Width
- Jib For Outreach
- Zero Tail-swing



E300AJP Working Height 10.97m

Make	JLG	Platform Area	1.22m x 0.76m
Model	E300AJP	Safe Working Load	227kg
Working Height	10.97m	Weight	7100kg
Platform Height	8.97m	Power Source	Electric
Working Outreach	6.12m		
Width	1.22m		
Closed Height	2.01m		
Closed Length	5.74m		

Alternative Machines Z30/20 RJ / HR12N

IPAF License 3B



- Narrow Width
- Jib For Outreach
- Zero Tail-swing

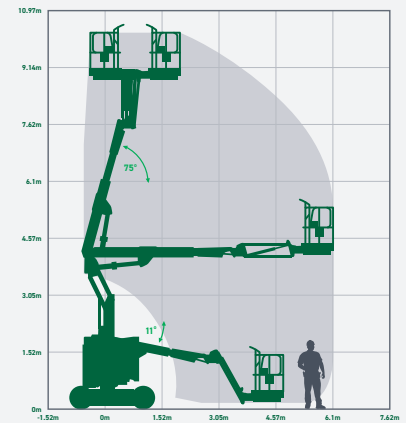

HR12N Working Height 12.2m

Make	Niftylift	Platform Area	1.1m x 0.65m
Model	HR12N	Safe Working Load	200kg
Working Height	12.2m	Weight	3435kg
Platform Height	10.2m	Power Source	Hybrid
Working Outreach	6.1m		
Width	1.5m		
Closed Height	1.9m		
Closed Length	4.1m		

Alternative Machines Z34/22N / E400AJPN

IPAF License 3B

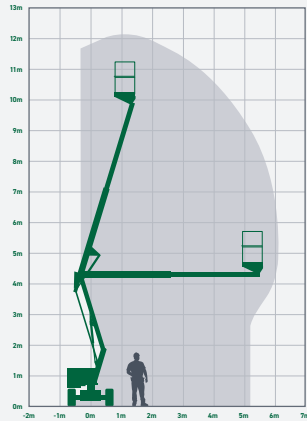

- Lightweight
- Narrow Articulating Boom
- Secondary Guarding Option
- Diesel Only Models Also Available

340AJ Working Height 12.33m

Make	JLG	Platform Area	1.52m x 0.76m
Model	340AJ	Safe Working Load	230kg
Working Height	12.33m	Weight	4400kg
Platform Height	10.33m	Power Source	Diesel
Working Outreach	6.06m		
Width	1.93m		
Closed Height	2m		
Closed Length	5.52m		

Alternative Machines HR12N

IPAF License 3B



- Rough Terrain
- Articulated Boom with Jib
- Secondary Guarding Option

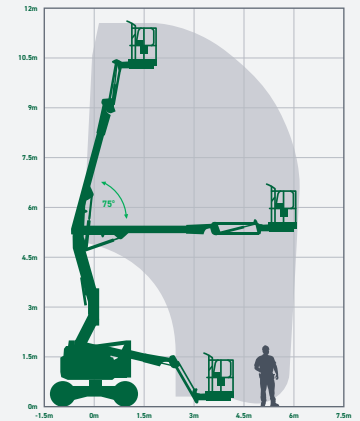

Z-34/22N Working Height 12.52m

Make	Genie	Platform Area	1.42m x 0.76m
Model	Z-34	Safe Working Load	227kg
Working Height	12.52m	Weight	5178kg
Platform Height	10.52m	Power Source	Electric
Working Outreach	6.78m		
Width	1.47m		
Closed Height	2m		
Closed Length	5.72m		

Alternative Machines HR15 / E400AJPN

IPAF License 3B



- Articulated Boom With Jib
- Secondary Guarding Option

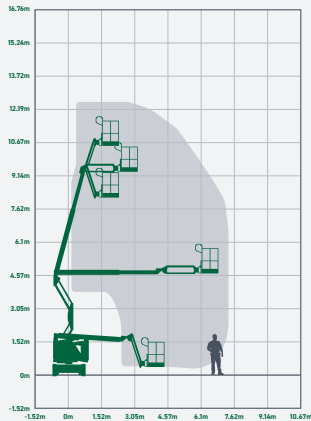

E400AJPN Working Height 14.19m

Make	JLG	Platform Area	1.22m x 0.76m
Model	E400AJPN	Safe Working Load	230kg
Working Height	14.19m	Weight	6850kg
Platform Height	12.19m	Power Source	Electric
Working Outreach	6.83m		
Width	1.5m		
Closed Height	1.97m		
Closed Length	6.71m		

Alternative Machines 240N / HR15 / E450AJ / Z45FE

IPAF License 3B



- Articulating Boom With Jib
- Zero Tail-swing
- Secondary Guarding Option

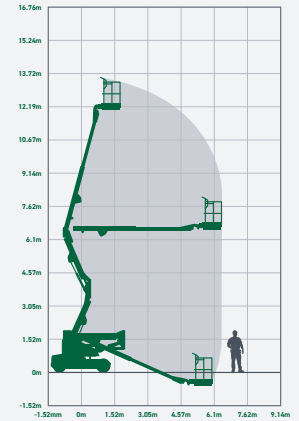

HR15N Working Height 15.5m

Alternative Machines E450AJ / Z45FE

IPAF License 3B



Make	Niftylift	Platform Area	1.5m x 0.8m
Model	HR15N	Safe Working Load	225kg
Working Height	15.5m	Weight	7250kg
Platform Height	13.5m	Power Source	Hybrid
Working Outreach	9.7m		
Width	1.5m		
Closed Height	1.99m		
Closed Length	6.4m		

- Narrow Articulating Boom With Jib
- Secondary Guarding Option

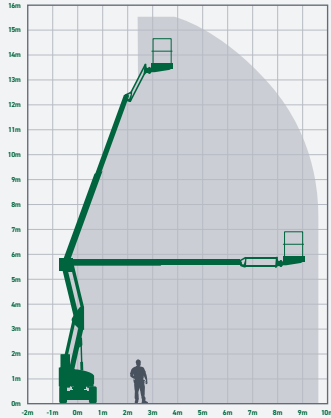

450AJ Working Height 15.72m

Alternative Machines Z45 / HR15N

IPAF License 3B

Make	JLG	Platform Area	1.83m x 0.76m
Model	450AJ	Safe Working Load	249kg
Working Height	15.72m	Weight	6418kg
Platform Height	13.72m	Power Source	Diesel
Working Outreach	7.62m		
Width	2.35m		
Closed Height	2.27m		
Closed Length	6.58m		



- Diesel Articulating Boom With Jib
- Secondary Guarding Option

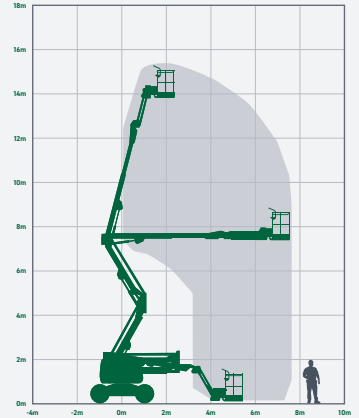

E450AJ

Working Height 15.72m

Make	JLG	Platform Area	1.52m x 0.76m
Model	E450AJ	Safe Working Load	226kg
Working Height	15.72m	Weight	6531kg
Platform Height	13.72m	Power Source	Electric
Working Outreach	7.24m		
Width	1.75m		
Closed Height	2.01m		
Closed Length	6.45m		

Alternative Machines HR15 / Z45FE / HR17

IPAF License 3B



- Articulating Boom With Jib
- Secondary Guarding Option

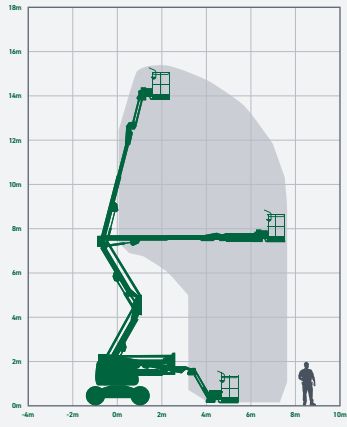

Z-45 XC

Working Height 15.86m

Make	Genie	Platform Area	1.83m x 0.76m
Model	Z-45 XC	Safe Working Load	454kg
Working Height	15.86m	Weight	7421kg
Platform Height	13.86m	Power Source	Diesel
Working Outreach	7.55m		
Width	2.29m		
Closed Height	2.25m		
Closed Length	6.65m		

Alternative Machines Z-45 FE

IPAF License 3B

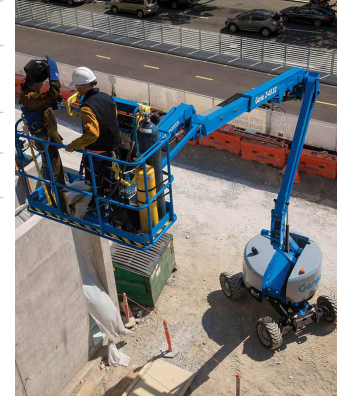

- Articulating Boom With Jib
- Secondary Guarding Option
- Increased SWL

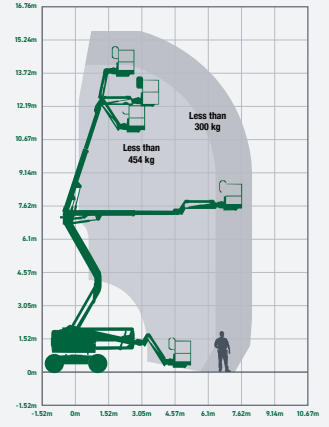

Z45/25J RT Working Height 15.86m

Make	Genie	Platform Area	1.83m x 0.76m
Model	Z45/25J RT	Safe Working Load	227kg
Working Height	15.86m	Weight	6515kg
Platform Height	13.86m	Power Source	Diesel
Working Outreach	7.52m		
Width	2.29m		
Closed Height	2.13m		
Closed Length	6.65m		

Alternative Machines 450AJ / HR15

IPAF License 3B

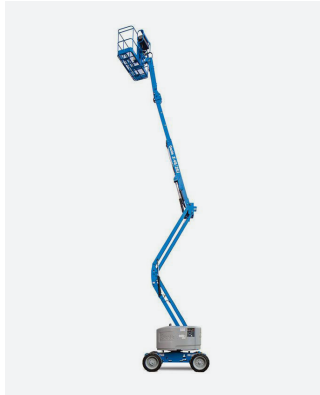

- Articulating Boom With Jib
- Secondary Guarding Option
- Rough Terrain

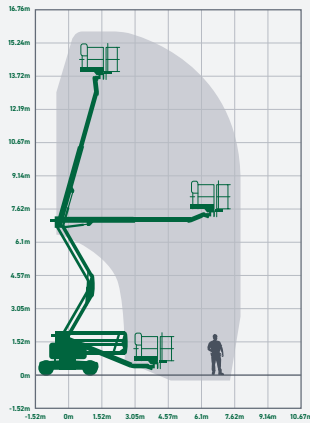

Z-45 FE Working Height 15.92m

Make	Genie	Platform Area	1.83m x 0.76m
Model	Z-45 FE	Safe Working Load	300kg
Working Height	15.92m	Weight	6559kg
Platform Height	13.92m	Power Source	Hybrid
Working Outreach	6.94m		
Width	2.29m		
Closed Height	2.29m		
Closed Length	6.11m		

Alternative Machines HR15 / E450AJ / HR17

IPAF License 3B

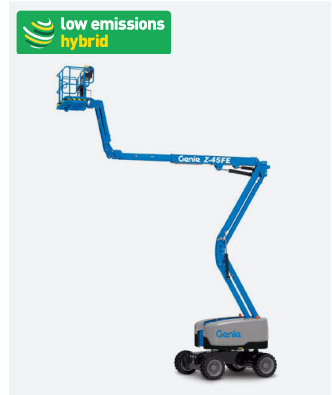

- Rough Terrain
- Articulating Boom With Jib
- Secondary Guarding Option

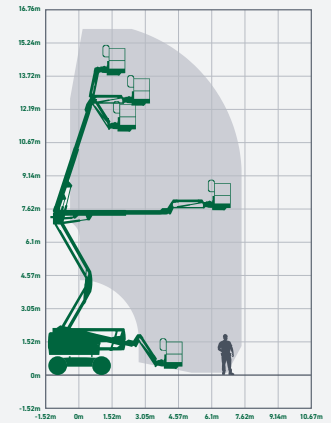

460SJ

Working Height 16.09m

Alternative Machines S65 / 660SJ

IPAF License 3B

Make	JLG	Platform Area	0.76m x 1.83m
Model	460SJ	Safe Working Load	270kg
Working Height	16.09m	Weight	7850kg
Platform Height	14.09m	Power Source	Diesel
Working Outreach	12.34m		
Width	2.31m		
Closed Height	2.39m		
Closed Length	8.84m		



- Telescopic Boom With Jib
- Secondary Guarding Option
- Rough Terrain

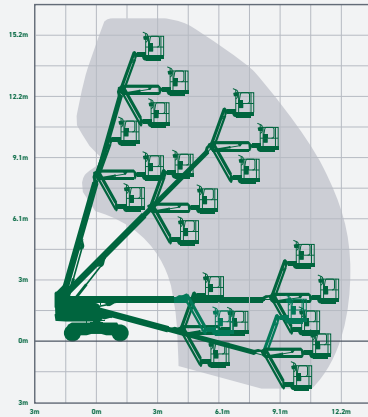

HR17N

Working Height 17m

Alternative Machine 510AJ

IPAF License 3B

Make	Niftylift	Platform Area	1.5m x 0.8m
Model	HR17N	Safe Working Load	225kg
Working Height	17m	Weight	7780kg
Platform Height	15m	Power Source	Hybrid
Working Outreach	9.7m		
Width	1.5m		
Closed Height	1.99m		
Closed Length	6.4m		

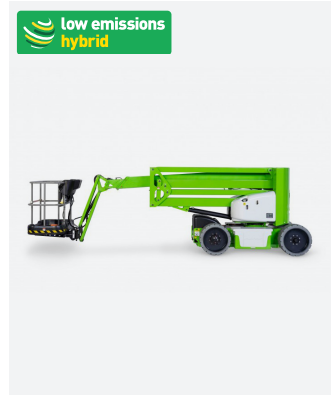

- Narrow Articulating Boom With Jib
- Secondary Guarding Option

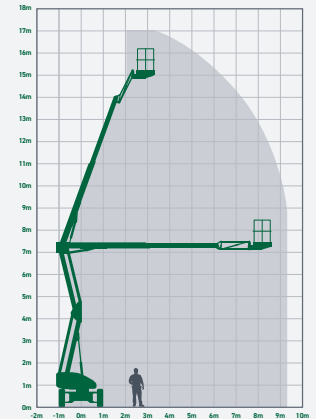

510AJ Working Height 17.81m

Make	JLG	Platform Area	1.83m x 0.76m
Model	510AJ	Safe Working Load	230kg
Working Height	17.81m	Weight	7650kg
Platform Height	15.81m	Power Source	Diesel
Working Outreach	9.48m		
Width	2.26m		
Closed Height	2.3m		
Closed Length	7.68m		

Alternative Machines HR17 / Z51

IPAF License 3B



- Articulating Boom With Jib
- Secondary Guarding Option
- Rough Terrain

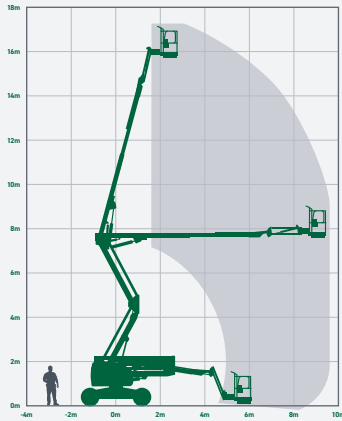

Z-60 FE Working Height 20.16m

Make	Genie	Platform Area	1.83m x 0.76m
Model	Z-60 FE	Safe Working Load	227kg
Working Height	20.16m	Weight	7300kg
Platform Height	18.16m	Power Source	Hybrid
Working Outreach	11.15m		
Width	2.49m		
Closed Height	2.54m		
Closed Length	8.15m		

Alternative Machine HR21

IPAF License 3B

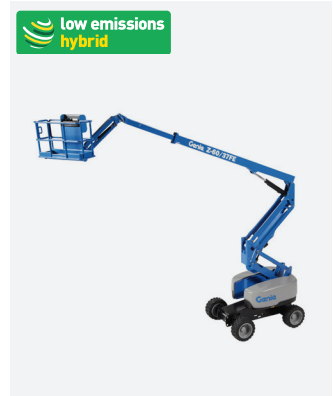

- Rough Terrain
- Articulating Boom With Jib
- Secondary Guarding Option

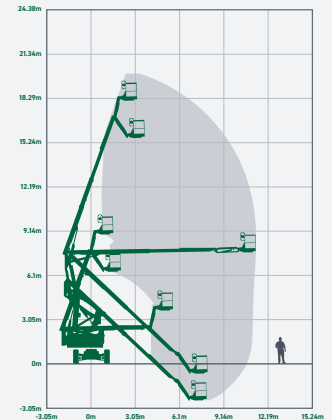

Z-60/34 Working Height 20.39m

Alternative Machines 600AJ / HR21

IPAF License 3B

Make	Genie	Platform Area	1.83m x 0.76m
Model	Z-60/34	Safe Working Load	227kg
Working Height	20.39m	Weight	11321kg
Platform Height	18.39m	Power Source	Diesel
Working Outreach	11.05m		
Width	2.46m		
Closed Height	2.69m		
Closed Length	8.15m		



- Articulating Boom With Jib
- Secondary Guarding Option
- Rough Terrain

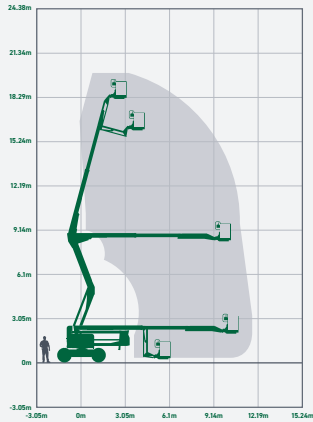

600AJ Working Height 20.46m

Alternative Machines Z60 / Z62 / HR21

IPAF License 3B

Make	JLG	Platform Area	2.44m x 0.91m
Model	600AJ	Safe Working Load	230kg
Working Height	20.46m	Weight	10660kg
Platform Height	18.46m	Power Source	Diesel
Working Outreach	12.75m		
Width	2.49m		
Closed Height	2.57m		
Closed Length	8.82m		

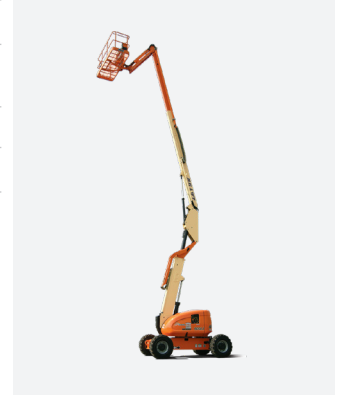

- Articulating Boom With Jib
- Secondary Guarding Option
- Rough Terrain

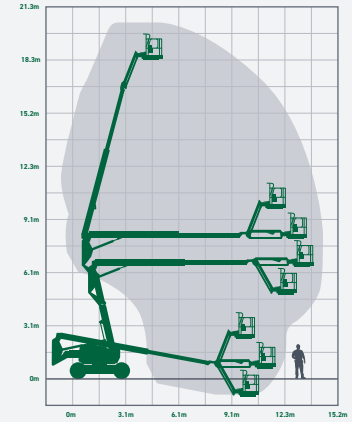

HR21 4X4 Working Height 20.8m

Make	Niftylift	Platform Area	1.8m x 0.8m
Model	HR21 4X4	Safe Working Load	250kg
Working Height	20.8m	Weight	6680kg
Platform Height	18.8m	Power Source	Hybrid
Working Outreach	13m		
Width	2.27m		
Closed Height	2.18m		
Closed Length	6.62m		

Alternative Machine Z60FE
IPAF License 3B

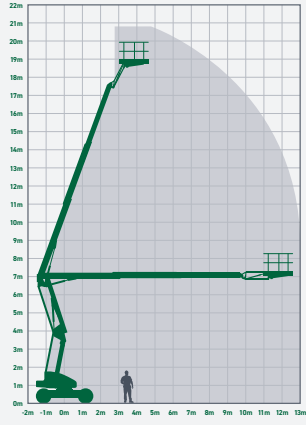

- Narrow Articulating Boom With Jib
- Secondary Guarding Option
- Diesel Only Models Also Available

Z62/40 Working Height 20.87m

Make	Genie	Platform Area	1.83m x 0.76m
Model	Z62/40	Safe Working Load	227kg
Working Height	20.87m	Weight	10292kg
Platform Height	18.87m	Power Source	Diesel
Working Outreach	12.42m		
Width	2.49m		
Closed Height	2.54m		
Closed Length	9.25m		

Alternative Machines HR21 / Z60 / 600AJ
IPAF License 3B



- Articulating Boom With Jib
- Secondary Guarding Option
- Rough Terrain

S-65 Working Height 21.8m

Make	Genie	Closed Length	9.42m
Model	S-65	Platform Area	1.83m x 0.76m
Working Height	21.8m	Safe Working Load	227kg
Platform Height	19.8m	Weight	10449kg
Working Outreach	17.1m	Power Source	Diesel
Width	2.49m		
Closed Height	2.72m		

Alternative Machine 660SJ
IPAF License 3B



- Telescopic Boom With Jib
- Secondary Guarding Option
- Rough Terrain

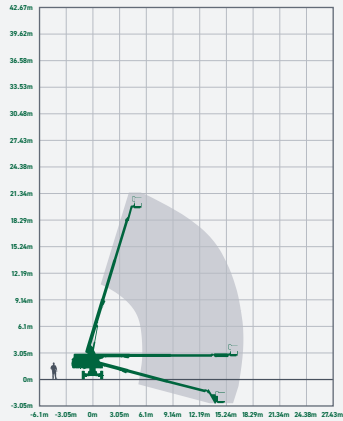

660SJ Working Height 22.02m

Make	JLG	Platform Area	2.44m x 0.91m
Model	660SJ	Safe Working Load	249kg
Working Height	22.02m	Weight	13282kg
Platform Height	20.02m	Power Source	Diesel
Working Outreach	17.4m		
Width	2.49m		
Closed Height	2.5m		
Closed Length	10.79m		

Alternative Machine S65
IPAF License 3B



- Telescopic Boom With Jib
- Secondary Guarding Option
- Rough Terrain

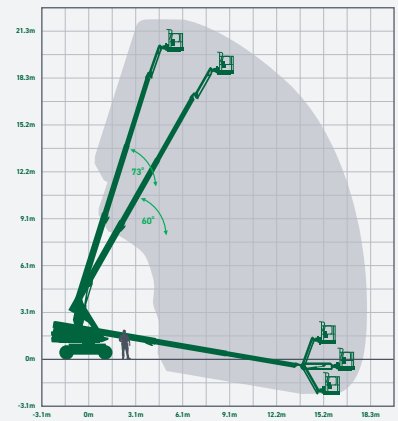

Z80/60 Working Height 26.2m

Make	Genie	Platform Area	1.83m x 0.76m
Model	Z80/60	Safe Working Load	227kg
Working Height	26.2m	Weight	17237kg
Platform Height	24.2m	Power Source	Diesel
Working Outreach	18.3m		
Width	2.49m		
Closed Height	3m		
Closed Length	11.3m		

Alternative Machine 800AJ
IPAF License 3B



- Articulated Boom With Jib
- Secondary Guarding Option
- Rough Terrain

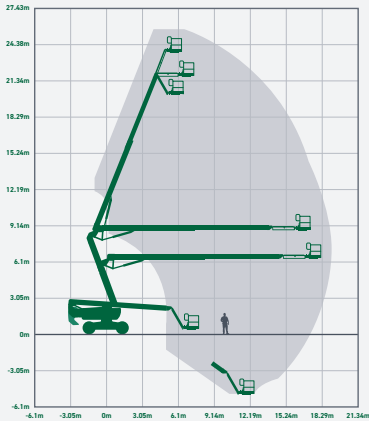

800AJ Working Height 26.46m

Make	JLG	Platform Area	2.49m x 0.91m
Model	800AJ	Safe Working Load	230kg
Working Height	26.38m	Weight	15600kg
Platform Height	24.38m	Power Source	Diesel
Working Outreach	15.74m		
Width	2.49m		
Closed Height	3m		
Closed Length	11.12m		

Alternative Machine Z80 / HR28
IPAF License 3B

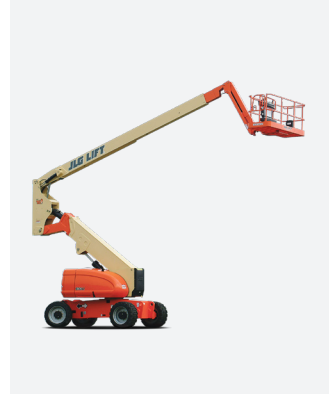

- Articulated Boom With Jib
- Secondary Guarding Option
- Rough Terrain

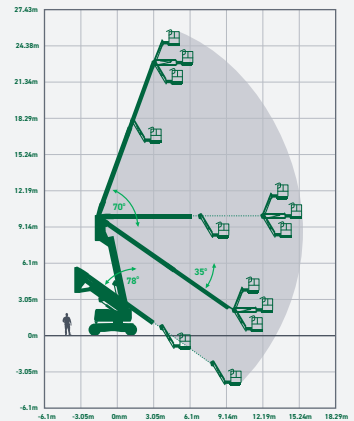

S-85 Working Height 27.7m

Make	Genie	Platform Area	1.83m x 0.76m
Model	S-85	Safe Working Load	227kg
Working Height	27.9m	Weight	17236kg
Platform Height	25.9m	Power Source	Diesel
Working Outreach	23.3m		
Width	2.25m		
Closed Height	2.8m		
Closed Length	12.2m		

Alternative Machine 860SJ
IPAF License 3B



- Telescopic Boom With Jib
- Secondary Guarding Option
- Rough Terrain

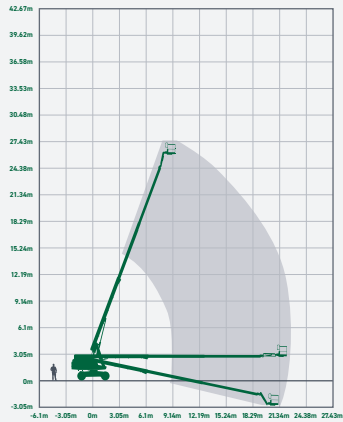

HR28 4x4 Working Height 28m

Make	Niftylift	Platform Area	2.4m x 0.9m
Model	HR28 4x4	Safe Working Load	280kg
Working Height	28m	Weight	14460kg
Platform Height	26m	Power Source	Hybrid
Working Outreach	19m		
Width	2.49m		
Closed Height	2.7m		
Closed Length	9.28m		

Alternative Machines Z80 / 800AJ
IPAF License 3B

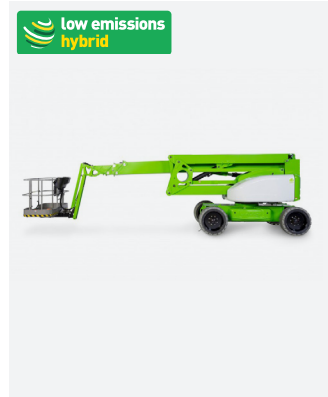

- Narrow Articulating Boom With Jib
- Secondary Guarding Option
- Diesel Only Models Also Available

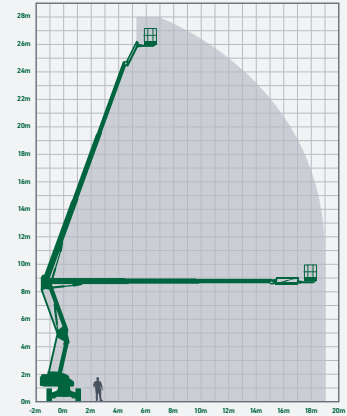

860SJ

Working Height 28.21m

Alternative Machine S85

IPAF License 3B

Make	JLG	Platform Area	2.44m x 0.91m
Model	860SJ	Safe Working Load	230kg
Working Height	28.21m	Weight	16732kg
Platform Height	26.21m	Power Source	Diesel
Working Outreach	22.86m		
Width	2.49m		
Closed Height	3.05m		
Closed Length	12.19m		



- Telescopic Boom With Jib
- Secondary Guarding Option
- Rough Terrain

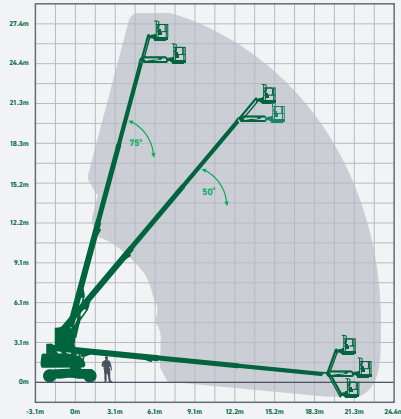

S-125

Working Height 40.15m

Alternative Machines 1250AJP / 1350SJP / ZX-135

IPAF License 3B

Make	Genie	Closed Height	3.07m
Model	S-125	Closed Length	14.25m
Working Height	40.15m	Platform Area	2.44m x 0.91m
Platform Height	38.15m	Safe Working Load	227kg
Working Outreach	24.38m	Weight	20248kg
Width (Axles Retracted)	2.49m	Power Source	Diesel
Width (Axles Extended)	3.35m		



- Telescopic Boom With Jib
- Secondary Guarding Option
- Rough Terrain

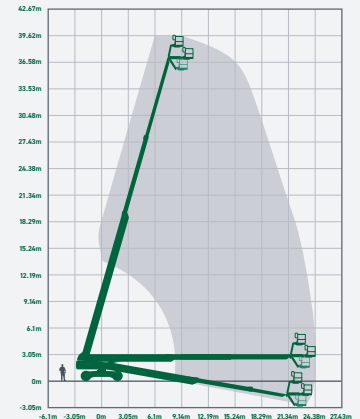

1250AJP Working Height 40.3m

Make	JLG	Closed Height	3.05m
Model	1250AJP	Closed Length	14.48m
Working Height	40.3m	Platform Area	2.44m x 0.91m
Platform Height	38.3m	Safe Working Load	230kg
Working Outreach	19.9m	Weight	21000kg
Width (Axles Retracted)	2.49m	Power Source	Diesel
Width (Axles Extended)	3.81m		

Alternative Machines Z135 / ZX135
IPAF License 3B



ZX-135 Working Height 43.15m

Make	Genie	Closed Height	3.09m
Model	ZX-135	Closed Length	12.93m
Working Height	43.15m	Platform Area	1.83m x 0.76m
Platform Height	41.15m	Safe Working Load	272kg
Working Outreach	21.26m	Weight	21092kg
Width (Axles Retracted)	2.49m	Power Source	Diesel
Width (Axles Extended)	5.03m		

Alternative Machine 1350SJP
IPAF License 3B



- Articulated Boom With Jib
- Secondary Guarding Option
- Rough Terrain

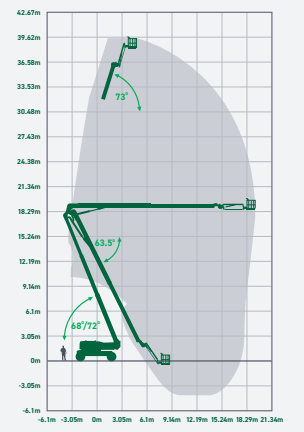

- Articulated Boom With Jib
- Secondary Guarding Option
- Rough Terrain

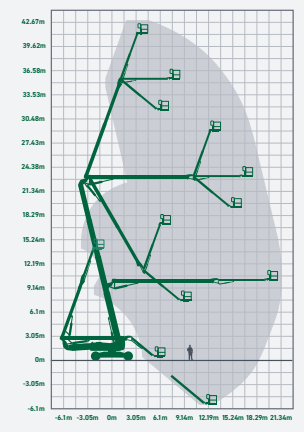

1350SJP Working Height 43.3m

Alternative Machine ZX135

IPAF License 3B

Make	JLG	Closed Height	3.05m
Model	1350SJP	Closed Length	14.89m
Working Height	43.3m	Platform Area	2.44m x 0.91m
Platform Height	41.3m	Safe Working Load	230kg
Working Outreach	25.03m	Weight	20400kg
Width (Axles Retracted)	2.49m	Power Source	Diesel
Width (Axles Extended)	3.81m		



- Telescopic Boom With Jib
- Secondary Guarding Option
- Rough Terrain

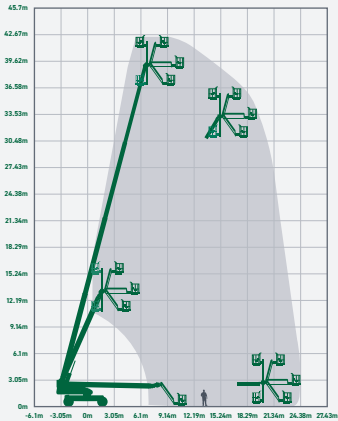



TRACKED ACCESS

Our tracked access boom lifts have working heights ranging from 12m (40ft) to over 26m (85ft). Combining the capabilities of trailer mounted and self-propelled booms, the track driven booms are compact, lightweight and manoeuvrable. Tracked machines can be walked into position on a lead. They offer maximum traction on steep gradients and hydraulic outriggers and allow fast setup and operation even on rough terrain. Easy to use proportional controls make our track drive simple to operate, and features such as telescopic booms, fly-booms and platform rotation maximise their effectiveness on any task.

TD120T

Working Height 12.2m

Make	Niftylift	Closed Length	3.95m
Model	TD120T	Platform Area	1.1m x 0.65m
Working Height	12.2m	Safe Working Load	200kg
Platform Height	10.2m	Weight	1890kg
Working Outreach	6.1m	Power Source	Hybrid
Closed Width	1.1m		
Full Working Width	3.55m		
Closed Height	1.9m		

IPAF License 1B

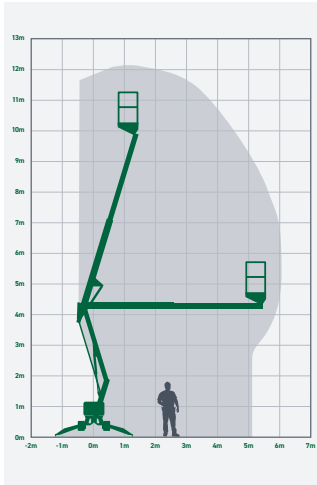

TD150T

Working Height 14.7m

Make	Niftylift	Closed Length	4.7m
Model	TD150T	Platform Area	1.4m x 0.7m
Working Height	14.7m	Safe Working Load	225kg
Platform Height	12.7m	Weight	2025kg
Working Outreach	7.55m	Power Source	Hybrid
Closed Width	1.4m		
Full Working Width	3.8m		
Closed Height	2m		

IPAF License 1B

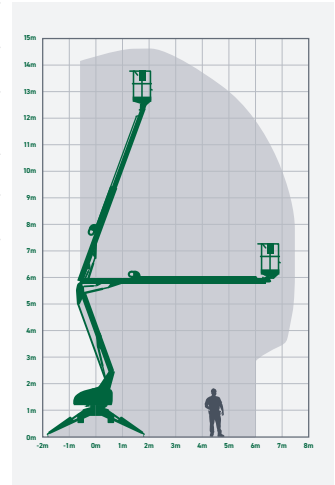

low emissions
hybrid



low emissions
hybrid



Lightlift 15.70 Working Height 15.4m

IPAF License 1B

Make	Hinowa	Closed Length	4.02m
Model	Lightlift 15.70	Platform Area	1.33m x 0.69m
Working Height	15.4m	Safe Working Load	230kg
Platform Height	17.4m	Weight	1950kg
Working Outreach	6.6m	Power Source	Diesel/ Plug-in electric
Closed Width	0.78m		
Full Working Width	2.8m x 2.8m		
Closed Height	1.990m		

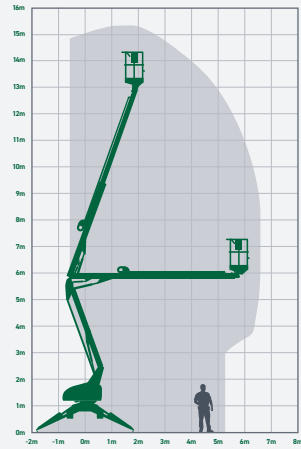

Lightlift 20.10 Working Height 20.1m

IPAF License 1B

Make	Hinowa	Closed Length	5.01m
Model	Lightlift 20.10	Platform Area	1.33m x 0.69m
Working Height	20.1m	Safe Working Load	230kg
Platform Height	18.1m	Weight	2840kg
Working Outreach	9.7m	Power Source	Diesel/ Plug-in electric
Closed Width	0.795m		
Full Working Width	2.922m x 2.925m		
Closed Height	1.998m		

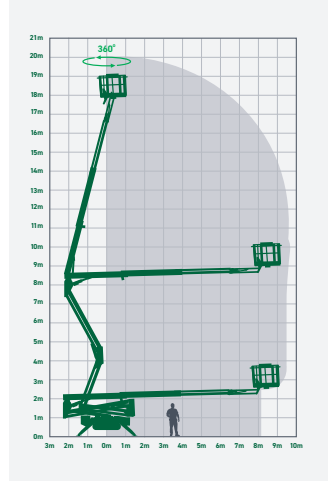

Lightlift 17.75 Working Height 17.06m

Make	Hinowa	Closed Length	4.529m
Model	Lightlift 17.75	Platform Area	1.33m x 0.69m
Working Height	17.06m	Safe Working Load	230kg
Platform Height	15.06m	Weight	2230kg
Working Outreach	7.5m	Power Source	Diesel/ Plug-in electric
Closed Width	0.79m		
Full Working Width	2.884m x 2.869m		
Closed Height	1.98m		

IPAF License 1B

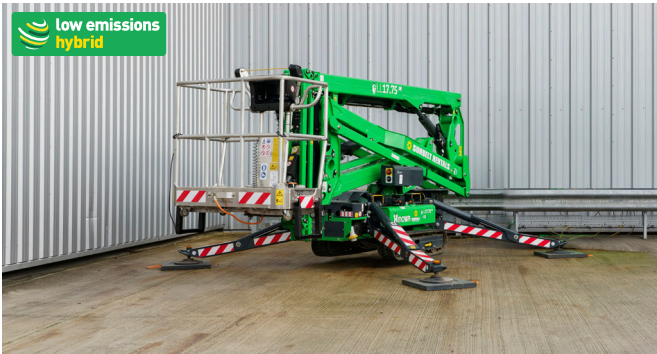
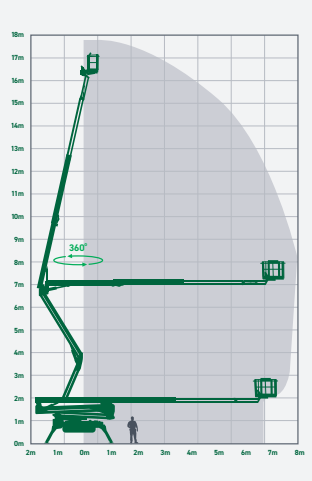

Lightlift 26.14 Working Height 25.7m

Make	Hinowa	Closed Height	1.981m
Model	LightLift 26.14	Closed Length	6.347m
Working Height	25.7m	Platform Area	1.33m x 0.69m
Platform Height	23.7m	Safe Working Load	230kg
Working Outreach	13.6m	Weight	4365kg
Closed Width	0.99m	Power Source	Diesel/ Plug-in electric
Full Working Width	5.351m x 3.978m (varied)		

IPAF License 1B

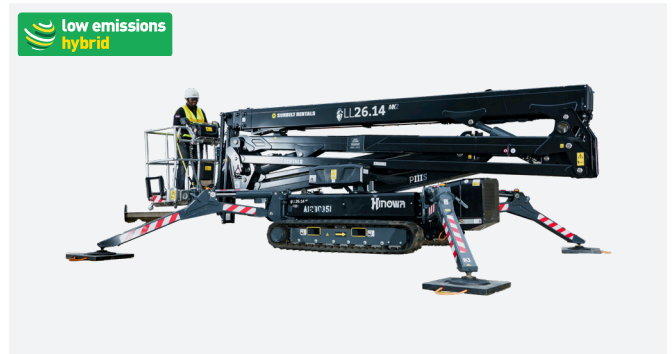
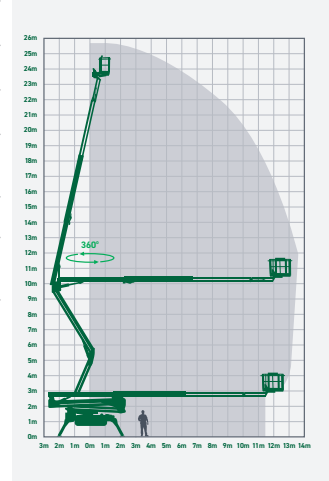

ACCESSORIES

Our range of ancillary products will maximise efficiency, platform workspace, and safety when working at height.

Additional equipment available to hire:

- PPE
- EQSS OverWatch
- Access and telemetry control
- Secondary guarding and intelligent secondary guarding
- Material handling attachments
- On board generators
- Transformers and leads
- Wheel covers and nappies
- Spark arrestors and chalywn valve
- Earth bonding



PRIMARY POWERED ACCESS DEPOTS

BARNSTAPLE

Fishleigh Rock, Umerleigh EX37 9DX
01769 560359
SouthWestPA@sunbeltrentals.co.uk

BELFAST

16 Michelin Road, Newtonabbey, Belfast BT36 4PT
0330 678 0813
belfast@sunbeltrentals.co.uk

BIRMINGHAM

100 Spring Road, Spon Lane Industrial Estate, Smethwick, Birmingham B66 1PE
0121 525 2711
midlands@sunbeltrentals.co.uk

BRIDGEND

1 George Thomas Avenue, Brynmenyn Industrial Estate, Brynmenyn, Bridgend CF32 9SQ
01656 725300
bridgendpoweredaccess@sunbeltrentals.co.uk

COLNBROOK

Waterman House, Colnbrook By Pass, Colnbrook, SL3 0ET
020 850 78111
sunbeltlondontemp@sunbeltrentals.co.uk

DUBLIN

Clondalkin Industrial Estate, 5B Besser Drive, Ballymanaggin, Dublin D22 K6Y4
00353 (0)14138620
dublin@sunbeltrentals.ie

EXETER

Mushroom Road, Hill Barton Business Park, Clyst St Mary, Exeter EX5 1DR
01793 826126
SouthWestPA@sunbeltrentals.co.uk

FAREHAM

Speedfields Park, Newgate Lane, Fareham PO14 1TS
01793 826126
SouthWestPA@sunbeltrentals.co.uk

KILMARNOCK

Holmquarry Road, Kilmarnock KA1 4DA
01563 528721
kilmarnockpoweredaccess@sunbeltrentals.co.uk

MAIDSTONE

Burial Ground Lane, Tovil, Maidstone, ME15 6RJ
020 850 78111
sunbeltlondontemp@sunbeltrentals.co.uk

MANCHESTER

Unit 2, Rugby Business Park, Gorse Street, Chadderton, Oldham OL9 9RJ
01617963399
northwest@sunbeltrentals.co.uk

MILTON KEYNES

2 Bridgeturn Avenue, Off Old Wolverton Road, Old Wolverton, Milton Keynes MK12 5QL
01908 579985
miltonkeynespa@sunbeltrentals.co.uk

NORWICH

Unit A Old Hall Road, Norwich NR4 6ES
01603 456636
norwichplanttools@sunbeltrentals.co.uk

NOTTINGHAM

10 Bull Close Road, Lenton Industrial Estate, Nottingham NG7 2UL
0115 958 0085
nottinghampoweredaccess@sunbeltrentals.co.uk

ROTHERHAM

Unit B1 Swinton Bridge Industrial Estate, Whitelea Road, Swinton S64 8BH
01709 588890
rotherhampa@sunbeltrentals.co.uk

STOCKTON

Lockheed Close, Preston Farm Industrial Estate, Stockton-on-Tees TS18 3SE
01642 608573
northeast@sunbeltrentals.co.uk

SWINDON

Radway Road, Britannia Business Park, Swindon SN3 4ND
01793 826126
SouthWestPA@sunbeltrentals.co.uk

WHITEHAVEN

Red Lonning Industrial Estate, Hensingham, Whitehaven CA28 6SJ
01946 64613
whitehavenplanttools@sunbeltrentals.co.uk



PROVIDING RENTAL EQUIPMENT AND MANAGED SOLUTIONS INTO EVERY MARKET AND SECTOR

SCAN TO VIEW OUR POWERED ACCESS EQUIPMENT



Plant

The widest range of plant including the latest stage v and battery powered machines in the UK



Plant Attachments

The sole UK distributor for several of the world's leading attachment manufacturers



Powered Access

The combined height and reach of our equipment can transport you safely over 50,000 metres



Lifting

Our solutions have been used on 7/10 of the tallest buildings in the UK



Energy

From fuel saving cleaner energy solutions to the latest stage v generators, we have a temporary power solution for every site.



Tools

From battery powered hand tools to compressors, compactors and cleaning equipment we offer a wide range of tool hire that's local to you



Industrial

On your site to meet the demands where every second counts



Utilities

The UK's largest specialist Utility hire company



Safety & Communications

Knowledgeable and experienced specialists in this field



Survey

Industry-leading supplier of land survey and precision measurement technologies



Test & Monitoring

Europe's leading test equipment specialists since 1996



Non-Mech

Essentials for every site; fencing, barriers, trenching, ground protection, vehicle and pedestrian control solutions



Climate Control

Economical and efficient temperature control and HVAC solutions



Accommodation

24/7/365 call out facility covering 20,000 items on fleet



Trakway

Award winning engineered access and ground protection solutions



Traffic Management

24/7 national coverage with operations covered by QEHSS accreditations



Barriers & Fencing

Crowd control and perimeter security solutions



Lighting

The UK's largest fleet of state-of-the-art tower lights, including a wide range of solar, hybrid and plug-in options.



Rail

We support the Network Rail and Transport for London infrastructure



Hoists

We hold over 10km of most sections, enough to scale London's Shard building over 32 times



Formwork & Falsework

We are the exclusive hire supplier of MEVA products in the UK



Training

Dedicated Health and Safety training to qualify our own people and our customer's people



Film & TV

From cameras, grip and lighting to backlot infrastructure



Flooring Solutions

Floor care and maintenance equipment to prepare, clean and maintain any floor, any size, anywhere

www.sunbeltrentals.co.uk