



SUNBELT[®]
RENTALS

LIFTING



**WE ARE A SKILLED
TEAM, READY
TO PROVIDE THE
KNOWLEDGE,
EXPERTISE AND
EQUIPMENT FOR
SAFE LIFTING
& HANDLING
OPERATIONS.**

Sunbelt Rentals offers a wide range of quality lifting and material handling equipment for hire and sale from industry leading manufacturers.

We also have one of the most technically experienced teams in the industry who are ready to assist with your lifting equipment needs.



FLG Services are now
Sunbelt Rentals
Lifting



WELCOME

Our services include:

Hire and sales of globally branded lifting equipment

Inspections, repair and testing of customers equipment available both onsite and in our service centres.*

Site inspection and testing of loose and static lifting equipment

Online certificate management

Technical site surveys

Delivery throughout the UK

Full Member of Lifting Equipment Engineers Association

*Depending on the equipment type.

All our equipment is CE compliant, designed to reduce the health and safety risks from lifting, backed by a full service and maintenance history.

We have one of the most technically experienced teams in the industry, with dedicated personnel who are ready to deal with your lifting and handling enquiries.



Lifting Equipment
Engineers Association



PRE-HIRE CHECKLIST

Our pre-hire checklist is available to ensure you hire the correct equipment for the job.

The peace of mind that comes from using Sunbelt Rentals as a supplier with fully maintained and regularly serviced equipment means that you can focus your time on other areas based on the knowledge that your lifting gear requirements are being met by a team of experts.

How to navigate your way around our brochure:

We have colour-coded our application areas to save you time and help you find exactly what you need. Please refer to the product link with each product for associated tackle for your required equipment. There is also a product index to enables you to source the equipment directly.

1. WHAT IS THE MAXIMUM WEIGHT OF THE LOAD?
2. WHAT HEIGHT OF LIFT OR LENGTH OF ROPE DO YOU REQUIRE?
3. DO YOU HAVE AN ADEQUATE AND SAFE SUSPENSION/ ANCHORAGE POINT?
4. HAVE YOU CONSIDERED ANY RESTRICTIONS THAT MAY AFFECT THE EQUIPMENT YOU CHOOSE - HEIGHT, WEIGHT, WIDTH?
5. HAVE YOU ASSESSED THE LOCATION WHERE THE EQUIPMENT IS TO BE USED?
6. WHAT POWER SUPPLY DO YOU HAVE AVAILABLE?
7. DO YOU REQUIRE ANY FURTHER EQUIPMENT?



Hoisting



Winching



Jacking



General Tackle



Material Handling



Safety



Load Measurement







Crane Hire and Heavy Lift



HOISTING





- HAND OPERATED CHAIN BLOCKS
- ELECTRIC CHAIN BLOCKS
- PORTABLE HOISTS - MINIFORS
- AIR OPERATED HOISTS
- LEVER OPERATED HOIST
- TIRAK MOBILE WINCH
- GIRDER CLAMPS/TROLLEYS
- BUILDER/SCAFFOLD HOISTS
- PLATE LIFTING CLAMPS
- QUICK RELEASE SHACKLES



	<p>HAND OPERATED CHAIN BLOCKS</p> <p>0.5t - 35t SWL</p> <p>Lightweight</p> <p>3m - 30m height of lift as standard, longer available on request.</p> <p>Heavy duty</p> <p>Report of Thorough Examination Supplied</p>	<p>Product Link</p> <ul style="list-style-type: none"> Slings Shackles Girder Clamps Girder Trolleys Digital Load Indicator
	<p>LEVER OPERATED HOISTS</p> <p>0.5t - 10t SWL</p> <p>Suitable for lifting and hauling operations</p> <p>1.5m height of lift as standard</p> <p>Ratchet design</p> <p>Longer lengths (height of lift) available upon request</p> <p>Report of Thorough Examination Supplied</p>	<p>Product Link</p> <ul style="list-style-type: none"> Slings Shackles Girder Clamps Girder Trolleys
	<p>ELECTRIC CHAIN BLOCKS</p> <p>0.25t - 10t SWL</p> <p>3m - 30m height of lift as standard, longer available on request.</p> <p>110V - 220V - 415V Availability</p> <p>Heavy duty</p> <p>Remote control available</p> <p>Report of Thorough Examination Supplied</p>	<p>Product Link</p> <ul style="list-style-type: none"> Slings Shackles Girder Clamps Girder Trolleys Digital Load Indicator
	<p>AIR OPERATED HOISTS</p> <p>0.5t - 50t SWL</p> <p>3m - 50m height of lift as standard, longer available on request.</p> <p>Heavy duty, continuous use</p> <p>Report of Thorough Examination Supplied</p>	<p>Product Link</p> <ul style="list-style-type: none"> Slings Shackles Girder Clamps Girder Trolleys Digital Load Indicator

	PORTABLE HOISTS - MINIFORS	Product Link
	0.3t - 1t SWL	 Slings Shackles
	3m - 200m Height of lift	 Girder Clamps Girder Trolleys
	110V - 220V - 415V Availability	 Digital Load Indicator
	Remote control available	
	Report of Thorough Examination Supplied	

	TIRAK MOBILE WINCH	Product Link
	1t - 3t SWL	 Slings Shackles
	Suitable for lifting and hauling operations	 Girder Clamps Girder Trolleys
	Heavier loads can be accommodated with snatch block utilisation	 Digital Load Indicator
	Ideal for lift shaft maintenance and cable pulling	 Snatch Blocks
	415V - 3ph - 50Hz · Unlimited heights of lift available	
	Report of Thorough Examination Supplied	

	GIRDER CLAMPS	Product Link
	1t - 20t SWL	 Slings Shackles
	Easy installation	 Chain Blocks Lever Hoists Air Hoists
	Suitable for lifting and hauling operations	 Digital Load Indicator
	Adjustable to accommodate beam dimensions	
	Report of Thorough Examination Supplied	









	GIRDER TROLLEYS (PUSH/GEARED)	Product Link
	1t - 15t SWL	 Slings Shackles
	Easy installation	 Chain Blocks Lever Hoists Air Hoists
	Adjustable to accommodate beam dimensions	
	Geared travel option available	
	Report of Thorough Examination Supplied	

	PLATE LIFTING CLAMPS	Product Link
	0.5t - 10t SWL	 Wire Ropes Slings Shackles
	0 - 50mm plate suitability	 Hand Operated Chain Hoist Air Hoist Electric Hoist
	Vertical and horizontal optional available	
	Report of Thorough Examination Supplied	

	SCAFFOLD HOIST	Product Link
	200kg SWL	 Webbing Slings Shackles Chain Slings Wheel Barrow Chain Sling
	110V	
	Easy to erect	
	Extremely versatile	
	Report of Thorough Examination Supplied	

	BUILDERS GANTRY HOIST	Product Link
	300kg and 500kg	 Webbing Slings Shackles Chain Slings Wheel Barrow Chain Sling
	415V (300kg available in 110V)	
	Easy to erect	
	80L and 150L bucket attachments available to hire	
	Extremely versatile	
	Report of Thorough Examination Supplied	

	QUICK RELEASE SHACKLES	Product Link
	Up to 10t SWL	 Wire Rope Slings Shackles Fibre Slings
	Ground release operation	 Electric Hoist Hand Operated Hoist Air Hoist.
		 Lifting Beams
	Report of Thorough Examination Supplied	

HOISTING

For larger transportation of materials and for passengers, our dedicated Hoist depots can offer Passenger and Goods Hoists, Goods Only Hoists, Bespoke Hoists and Transport Platforms with up to 3,200kg capacity and dimensions up to 2m wide and 6m long.

Head to www.sunbeltrentals.co.uk for further info.















HOISTING





WINCHING



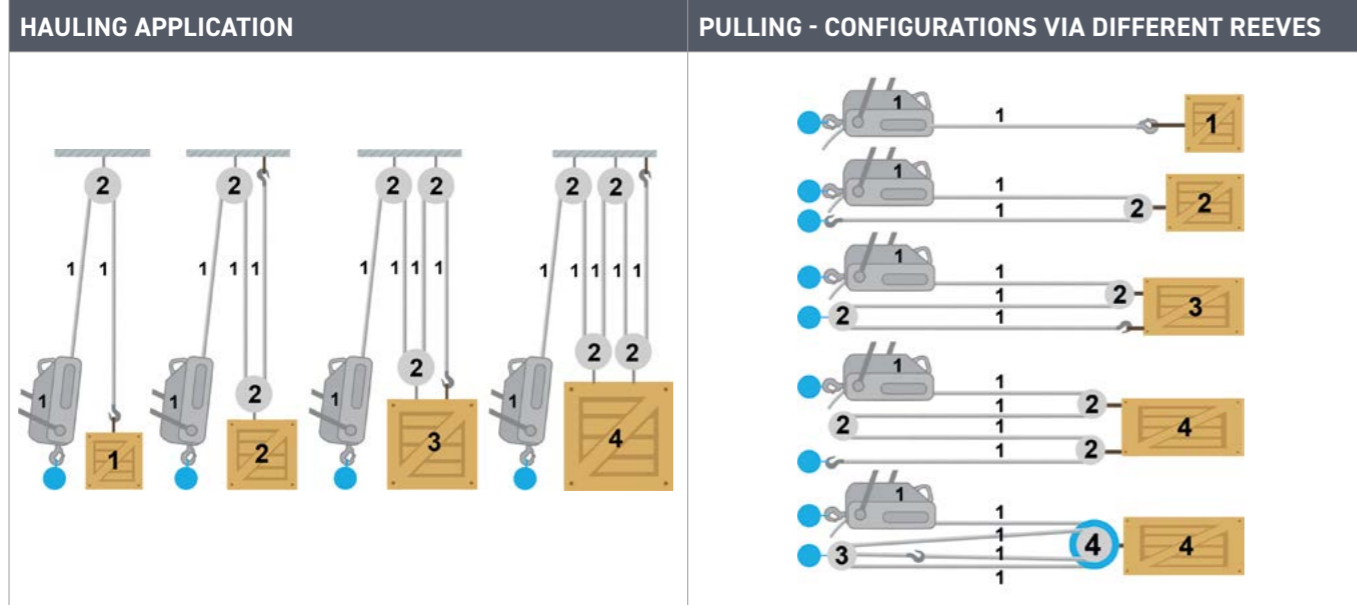
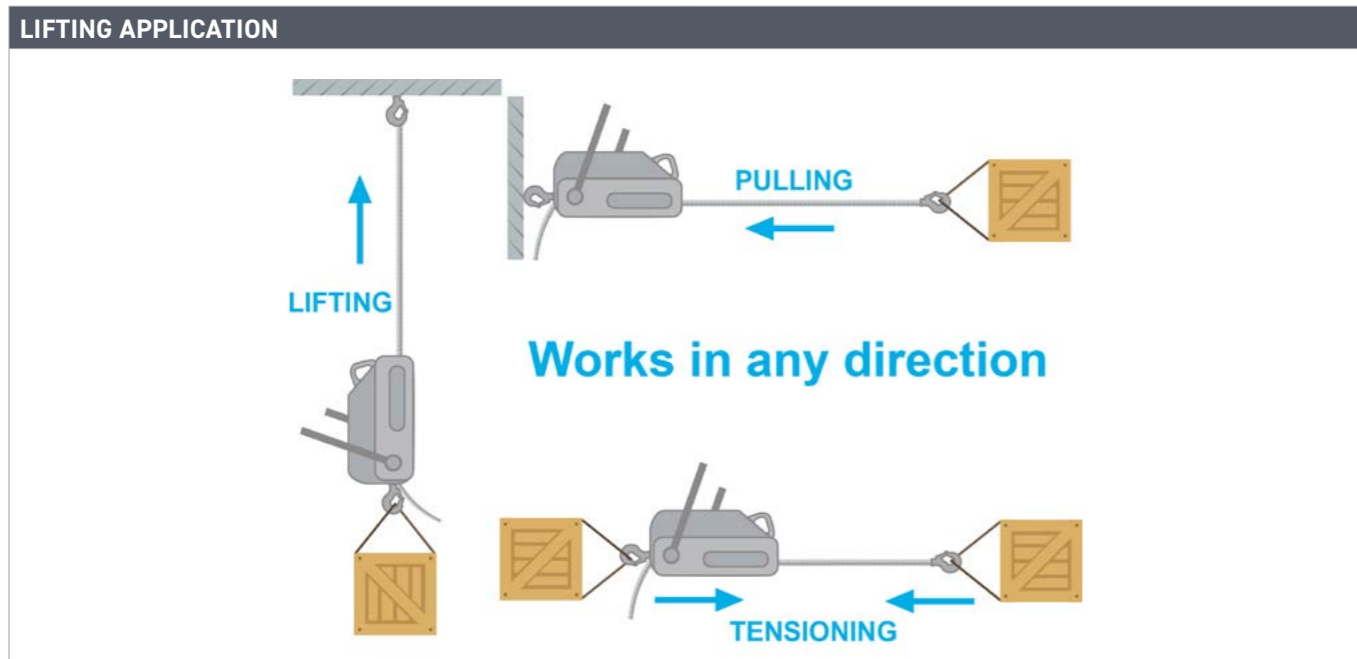

- TIRAKS
- PULLING MACHINES
- HYDRAULIC PULLING MACHINES
- WINCHES
- SNATCH/REEVING BLOCKS
- CABLE DRUM TRAILER
- CAPSTAN WINCH
- CABLE ROLLERS













	<p>PULLING MACHINES</p> <p>0.8t to 5t SWL</p> <p>Suitable for lifting and hauling operations</p> <p>Unlimited rope lengths available</p> <p>Report of Thorough Examination Supplied</p>	<p>Product Link</p> <p> Slings Shackles</p> <p> Digital Load Indicator</p>
	<p>HYDRAULIC PULLING MACHINES</p> <p>Pneumatic, Electric and Petrol powered</p> <p>0.8t to 5t SWL</p> <p>Suitable for lifting and hauling operations</p> <p>Unlimited rope lengths available</p> <p>Report of Thorough Examination Supplied</p>	<p>Product Link</p> <p> Slings Shackles</p> <p> Digital Load Indicator</p>
	<p>WINCHES</p> <p>0.5t - 10t SWL</p> <p>Pneumatic, Electric, Diesel and Petrol powered</p> <p>Diesel and Petrol powered</p> <p>Heavy duty</p> <p>Lifting and hauling application</p> <p>Report of Thorough Examination Supplied</p>	<p>Product Link</p> <p> Slings Shackles</p> <p> Digital Load Indicator</p> <p> Cable Rollers Snatch/ Reeving Blocks</p>
	<p>SNATCH/REEVING BLOCKS</p> <p>For use with varying diameters of wire rope</p> <p>Increases lifting/hauling capacity</p> <p>Enables the direction of lift/haul to be changed</p> <p>Report of Thorough Examination Supplied</p>	<p>Product Link</p> <p> Slings Shackles</p> <p> Winches Pulling Machines Hydraulic Pulling Machines</p>



CABLE DRUM TRAILER		Product Link
	Equipped with a manual hydraulic pump to lift up to 2350kg payload	 Winches  Pulling Machines  Hydraulic Pulling Machines  Cable Rollers
	Road towable	
	1280mm Maximum drum width	
	2500mm Maximum drum diameter	
	1060mm Minimum drum diameter	
	76mm Spindle diameter	









CAPSTAN WINCHES		Product Link
	For Telecommunications cable, general cabling and sub duct work	 Cable Trailer  Cable Rollers
	Pulls up to 3000kg of line	
	Line speeds of 0-12m/min @ 3000kg and 0-30m/min @ 1000kg	
	15.5hp water cooled diesel engine	 Slings  Shackles

CABLE ROLLERS		Product Link
	A wide variety of cable rollers to guide and protect cable during pulling operations;	 Cable Trailer  Winches  Capstan Winch  Pulling Machines  Hydraulic Pulling Machines
	• Cable Rollers	
	• Triple Corner Rollers	
	• Manhole Rollers	









CABLE DRUM JACKS		Product Link
	Up to 10t SWL	 Winches  Cable Rollers  Pulling Machine  Hydraulic Pulling Machine
	Adjustable in height	
	Robust construction	
	A heavy duty aid for cable laying	
	Report of Thorough Examination Supplied	

JACKING

- HYDRAULIC RAMS
- HYDRAULIC PUMPS AND HOSES
- MANIFOLDS
- GAUGES
- ELECTRIC PUMPS
- HYDRAULIC JACKS
- RATCHET TOE JACKS
- CABLE DRUM JACKS
- TROLLEY JACKS
- LOW HEIGHT CYLINDERS

	<p>HYDRAULIC RAMS</p> <p>Up to 500t SWL</p> <p>Varying sizes available</p> <p>Hi-flow coupling operation</p> <p>Single acting, double acting, low height, screwed and hollow models available</p> <p>Can be used in multiples to suit requirements</p> <p>Report of Thorough Examination Supplied</p>	<p>Product Link</p> <p>  Manifolds Pumps Hoses Gauges </p>
	<p>HYDRAULIC PUMPS & HOSES</p> <p>Hand and powered operation</p> <p>Choice of oil capacity</p> <p>Portable</p> <p>Multi-ram operation available if required</p> <p>Report of Thorough Examination Supplied</p>	<p>Product Link</p> <p>  Hydraulic Ram Gauge Hydraulic Hose Manifold </p> <p>  Compressive Load Cell </p>
	<p>MANIFOLDS</p> <p>For use with multiple ram applications</p> <p>Enables synchronised lifting from a single pump</p> <p>Various sizes available up to 8 ports</p> <p>Report of Thorough Examination Supplied</p>	<p>Product Link</p> <p>  Hydraulic Ram Hydraulic Pump and Hoses </p>
	<p>GAUGE</p> <p>Allows constant pressure monitoring</p> <p>Accurate to ±1 % of full scale</p> <p>Sizes to suit various applications</p>	<p>Product Link</p> <p>  Hydraulic Ram Hydraulic Pump and Hoses Manifolds </p>

JACKING

	<p>ELECTRIC PUMPS</p> <p>Various power set ups available</p> <p>Battery power, 240V and 110V available</p> <p>Various reservoir sizes available for multiple ram set ups</p> <p>Available with manual valve load holding feature</p> <p>Externally adjustable pressure relief valve</p>	<p>Product Link</p> <p> Hydraulic Ram Hoses Gauge Manifolds</p>
	<p>HYDRAULIC JACKS</p> <p>0.5t - 100t SWL</p> <p>Heavy duty</p> <p>Lifting and hauling application</p> <p>Report of Thorough Examination Supplied</p>	<p>Product Link</p> <p> Skoots Pallet Trucks</p>
	<p>RATCHET TOE JACKS</p> <p>Up to 20t SWL</p> <p>Portable</p> <p>Heavy duty</p> <p>Report of Thorough Examination Supplied</p>	<p>Product Link</p> <p> Skoots Pallet Trucks</p>
	<p>TROLLEY JACKS</p> <p>Up to 10t SWL</p> <p>Smooth lift operation</p> <p>Report of Thorough Examination Supplied</p>	<p>Product Link</p> <p> Pallet Trucks</p>

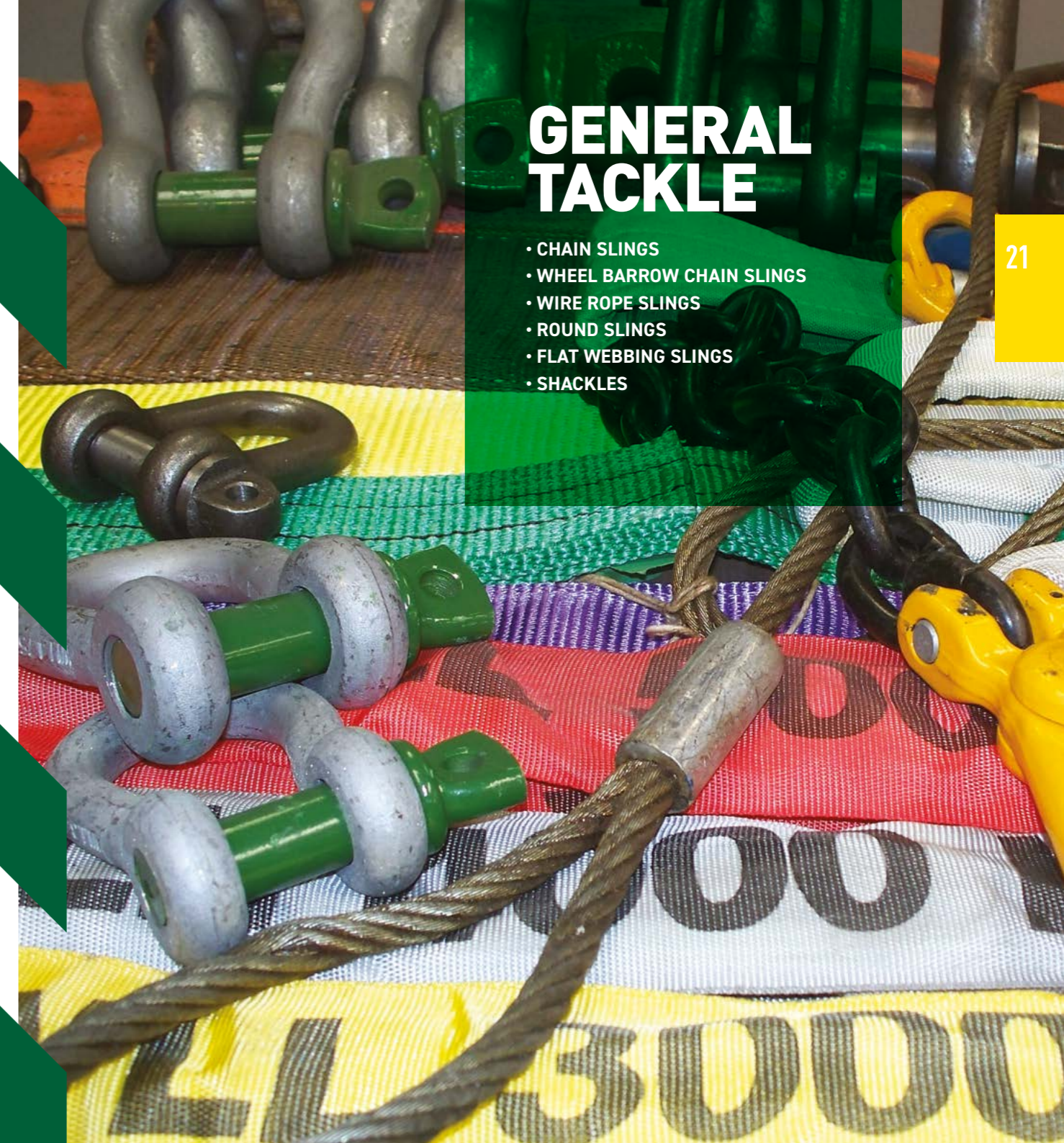

GENERAL TACKLE

- CHAIN SLINGS
- WHEEL BARROW CHAIN SLINGS
- WIRE ROPE SLINGS
- ROUND SLINGS
- FLAT WEBBING SLINGS
- SHACKLES



CHAIN SLINGS	Product Link
Up to 67t SWL	Wire Rope Slings Shackles Fibre Slings
Available from 7mm to 32mm construction	Load Measurement
Complete range of hooks available	Hoisting
Unlimited leg length	
Report of Thorough Examination Supplied	

Chain Size mm	Grade	Single Leg	Choke Hitch	Endless	Two Leg		Three and Four Leg	
					0°- 45°	45°- 60°	0°- 45°	45°- 60°
6	10	1.4	1.12	2.2	2.0	1.4	2.9	2.1
8	10	2.5	2.0	4.0	3.5	2.5	5.3	3.8
10	10	4.0	3.15	6.4	5.6	4.0	8.4	6.0
13	10	6.7	5.3	10.6	9.5	6.7	14.0	10.0
16	10	10.0	8.0	16.0	14.0	10.0	21.0	15.0
20	10	16.0	12.8	25.6	22.4	16.0	33.6	24.0
22	10	19.0	15.0	30.4	26.5	19.0	40.0	28.0
26	10	26.5	21.2	42.4	37.1	26.5	55.7	39.8
32	10	40.0	32.0	65.0	56.0	40.0	85.0	60.0

Advice for Use

DO

- Check the condition of the slings before use
- Check that the chain legs are not twisted
- Check that the load is on the centre of the hook and not the tip

DO NOT

- Do not carry out self repairs
- Do not use the slings over the maximum permissible limit or specified angle
- Do not shock load
- Do not use chain and accessories outside of temperature range -40°C and +200°C

	Grade	Number of Legs							
		1	2		3		4		
ANGLE	8	90°	0°- 45°	45°- 60°	0°- 45°	45°- 60°	0°- 45°	45°- 60°	
FACTOR	8	1	1.4	1	2.1	1.5	2.1	1.5	
7mm	8	1.50	2.12	1.50	3.15	2.24	3.15	2.24	
8mm	8	2.00	2.80	2.00	4.25	3.00	4.25	3.00	
10mm	8	3.15	4.25	3.15	6.70	4.75	6.70	4.75	
13mm	8	5.30	7.50	5.30	11.20	8.00	11.20	8.00	
16mm	8	8.00	11.20	8.00	17.00	11.80	17.00	11.80	
20mm	8	12.50	17.50	12.50	26.50	19.00	26.50	19.00	
22mm	8	15.00	21.20	15.00	31.50	22.40	31.50	22.40	
26mm	8	21.20	30.00	21.20	45.00	31.50	45.00	31.50	
32mm	8	31.50	45.00	31.50	67.00	47.50	67.00	47.50	



SLINGS (FLAT)	Product Link
Up to 230t SWL	Shackles Hoisting
Supplied in 1m increments	Winching
Safety factor 7:1	Material Handling
Protective sleeves available	Digital Load Indicator
Light weight and flexible	
Report of Thorough Examination Supplied	



SLINGS (ROUND)	Product Link
Up to 230t SWL	Shackles Hoisting
Supplied in 1m circumference increments	Winching
Safety factor 7:1	Material Handling
Protective sleeves available	Digital Load Indicator
Light weight and flexible	
Report of Thorough Examination Supplied	



WIRE ROPE SLINGS	Product Link
Up to 200t SWL	Shackles
Available in 1m increments up to 30m	Winching
Report of Thorough Examination Supplied	Hoisting Digital Load Indicator

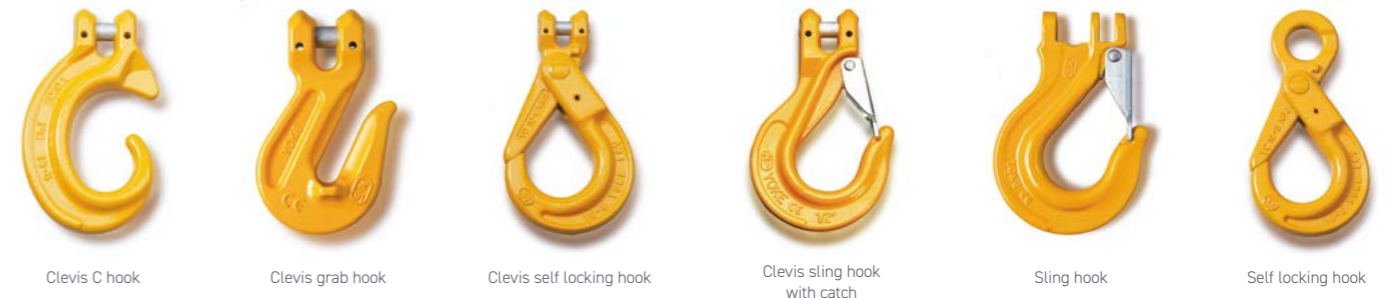

Round Slings

Including colour coded range, woven stripe, showing safe working load. 1 stripe = 1 tonne. Available with Tetra and heavy duty sleeve cover. Manufactured to EN1492-2 as applicable. Report of thorough examination supplied.



Flat Webbing Slings

Including colour coded range, soft eye and metal end fitting rings AL1, AL2, AL3, AL4, AL5. Duplex Manufactured to EN1492-1 as applicable.



Sling Type					Working Load Limit					
Webbing					Colour					
Duplex	Width	Endless	Width	Round		M = 1	M = 0.8	M = 2	M = 1.4	M = 1
D1	30	E1	30	R1	Violet	1	0.8	2	1.4	1
D2	60	E2	60	R2	Green	2	1.6	4	2.8	2
D3	90	E3	90	R3	Yellow	3	2.4	6	4.2	3
D4	120	E4	120	R4	Grey	4	3.2	8	5.6	4
D5	15			R5	Red	5	4	10	7	5
D6	180			R6	Brown	6	4.8	12	8.4	6
D8	240			R8	Blue	8	6.4	16	11.2	8
D10	300			R10	Orange	10	8	20	14	10
				R12	Orange	12	9.6	24	16.8	12
				R15	Orange	15	12	30	21	15
				R20	Orange	20	16	40	28	20
				R25	Orange	25	20	50	35	25
				R30	Orange	30	24	60	42	30

LARGE DEE SHACKLES C/W TYPE 'A' SCREW COLLAR PIN

- Meets the performance requirements of the withdrawn standard BS 3032
- Material: Carbon Steel C45
- Self coloured and hot dip galvanised finish available
- Proof load tested to 2 times the SWL
- Minimum breaking load is 4 times the SWL
- Marked with manufacturers mark, size ID mark and SWL
- Report of Thorough Examination Supplied

W.L.L (tonnes)	A (inches)	B (inches)	C (inches)	D (inches)	E (inches)	Weight (kg/each)
0.25	1/4	3/8	1/2	1	1/4	0.10
0.50	3/8	1/2	3/4	1 1/2	1	0.12
0.75	1/2	5/8	1 1/8	2 1/8	1 1/4	0.29
1.50	5/8	3/4	1 1/4	2 1/2	1 1/2	0.57
2.00	3/4	7/8	1 1/2	2 7/8	1 3/4	0.92
3.00	7/8	1	1 3/4	3 1/4	2	1.59
3.75	1	1 1/8	2	3 3/4	2 1/4	2.12
5.00	1 1/8	1 1/4	2 1/8	4 1/8	2 1/2	3.18
6.00	1 1/4	1 3/8	2 3/8	4 1/2	2 3/4	4.54
7.00	1 3/8	1 1/2	2 5/8	5	3	6.06
9.50	1 1/2	1 3/4	2 3/4	5 3/8	3 1/2	8.74



WE SELL AS WELL

Sunbelt Rentals also offers a wide range of products for sale to meet the needs of our customers who prefer to buy instead of hire.

The sale of lifting gear products is an area where the extensive experience of our staff will ensure you get the right product to facilitate your lifting and safety equipment requirements.

Every piece of equipment we offer is supported by an after-sales inspection and repair service which is based on the proven capabilities and resources which we devote to our own inventory of hire equipment.

Call 0808 196 9493 for sales.

Our range of lifting and safety equipment includes:

- Builders hoists
- Chain slings
- Chain blocks (manual and powered)
- Girder clamps/trolleys
- Fibre slings (duplex/round)
- Hydraulic jacks and rams
- Inertia reels
- Lever hoists
- Lashing systems
- Machine skates
- Pallet trucks
- Sack trucks
- Safety harnesses/lanyards
- Shackles
- Snatch blocks
- Pulling machines
- Winches
- Wire rope slings
- And much more

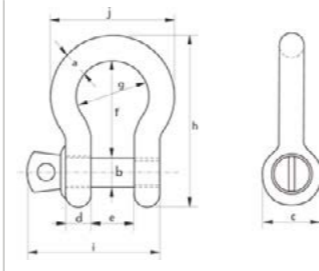

GREEN PIN STANDARD BOW SHACKLES WITH SCREW COLLAR PIN

- Grade 6 high tensile steel, quenched and tempered
- Minimum breaking load is 6 times the SWL
- Temperature range -20°C upto +200°C
- Report of Thorough Examination Supplied
- Conforms to EN 13889 and meets the performance requirements of US Fed Spec RC-C-271 Type IVA class 2, Grade A.
- Hot dipped galvanised

W.L.L (tonnes)	a (mm)	b (mm)	c (mm)	d (mm)	e (mm)	f (mm)	g (mm)	h (mm)	i (mm)	j (mm)	Weight (kg)
0.33	5	6	12.5	5	9.5	22	16	41	31	28	0.02
0.5	7	8	17	7	12	29	20	54	40	37	0.05
0.75	9	10	21	9	13.5	32	22	61	49	42	0.1
1	10	11	23	10	17	36.5	26	71	56	49	0.14
1.5	11	13	26	11	19	43	29	80	68	54	0.19
2	13.5	16	34	13.5	22	51	32	91	76	63	0.36
3.25	16	19	40	16	27	64	43	114	93	79	0.63
4.75	19	22	47	19	31	76	51	136	107	94	1.01
6.5	22	25	53	22	36	83	58	157	123	107	1.5
8.5	25	28	60	25	43	95	68	176	141	124	2.21
9.5	28	32	67	28	47	108	75	197	158	137	3.16
12	32	35	74	32	51	115	83	218	176	154	4.31
13.5	35	38	80	35	57	133	92	240	192	170	5.55
17	38	42	89	38	60	146	99	262	208	183	7.43
25	45	50	104	45	74	178	126	314	250	226	12.84
35	50	57	111	50	83	197	138	358	281	250	18.15
42.5	57	65	134	57	95	222	160	414	321	287	26.29
55	65	70	145	65	105	260	180	463	355	329	37.6

Want to buy?
 Please contact your local service centre or email productsales@sunbeltrentals.co.uk



MODULAR CANTILEVER LIFTING BEAM



DIFFERENT SIZES AVAILABLE ON REQUEST



Product Link

-  Slings
Shackles
-  Crane Hire

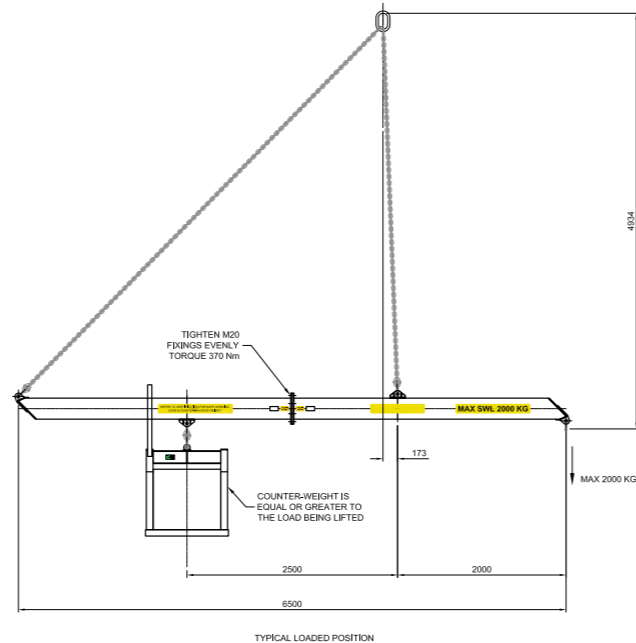
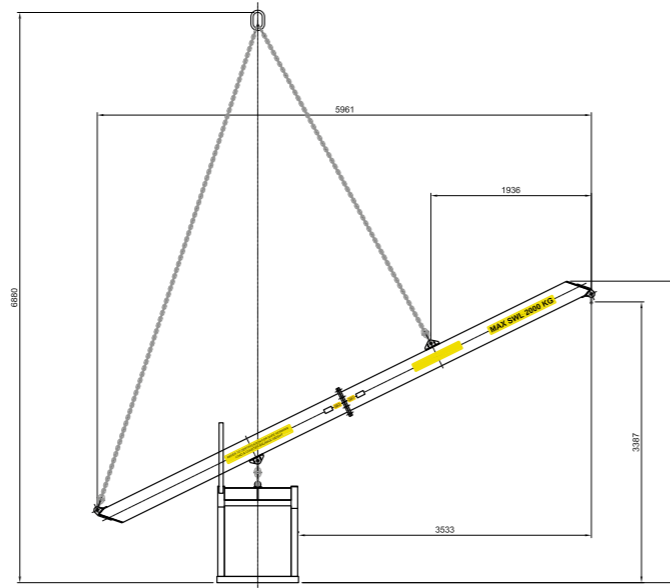

LIFTING BEAMS

- Up to 50 SWL
- 1m - 12m effective working lengths (subject to model type)
- Lightweight design
- Single or Multipoint Configuration
- Report of Thorough Examination Supplied

Product Link

-  Slings
Shackles
-  Digital Load Indicator
-  Crane Hire



LATTICE ROOF SHEET BEAM

- Up to 3t SWL
- Available up to 42m length in 3m sections
- Lightweight
- Report of Thorough Examination Supplied

Product Link

-  Slings
Shackles
-  Digital Load Indicator
-  Crane Hire



MODULAR SPREADER BEAMS (LIFTING BEAMS)

- up to 1000t
- 1m - 29m
- Mod Beam Cmod Beam
- Lattice Beam Cantilever Beam
- Spreader Beam

Product Link

-  Slings
Shackles
-  Digital Load Indicator
-  Crane Hire



CMOD MODULAR LIFTING FRAME

- Spans 0.5m to 16m
- Capacities 6t to 140t
- Contact local lifting service centre for bespoke quotation
- Report of Thorough Examination Supplied

Product Link

-  Slings
Shackles
-  Digital Load Indicator
-  Crane Hire

MODULAR SPREADER BEAMS

LOAD V SPAN CHART - MODULIFT SPREADER BEAM

STANDARD RANGE

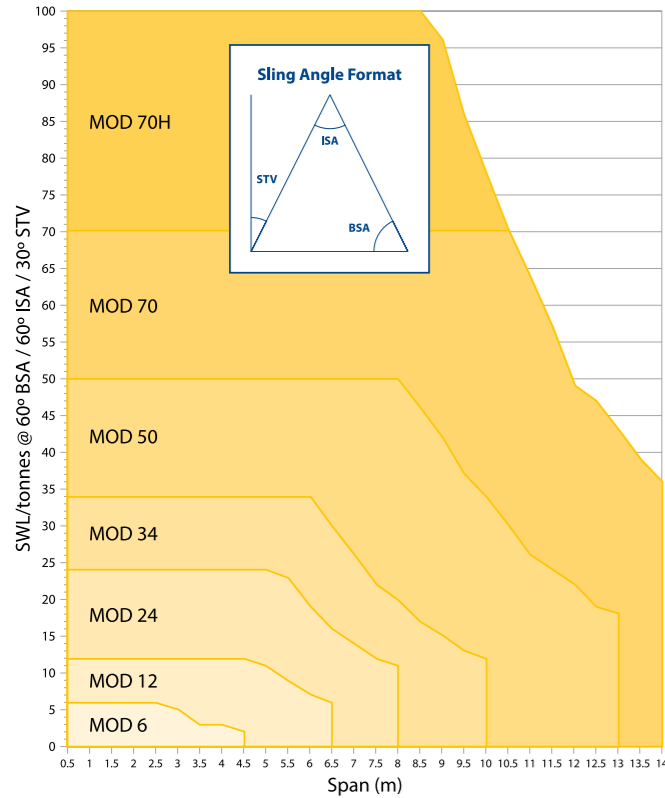

HEAVY RANGE

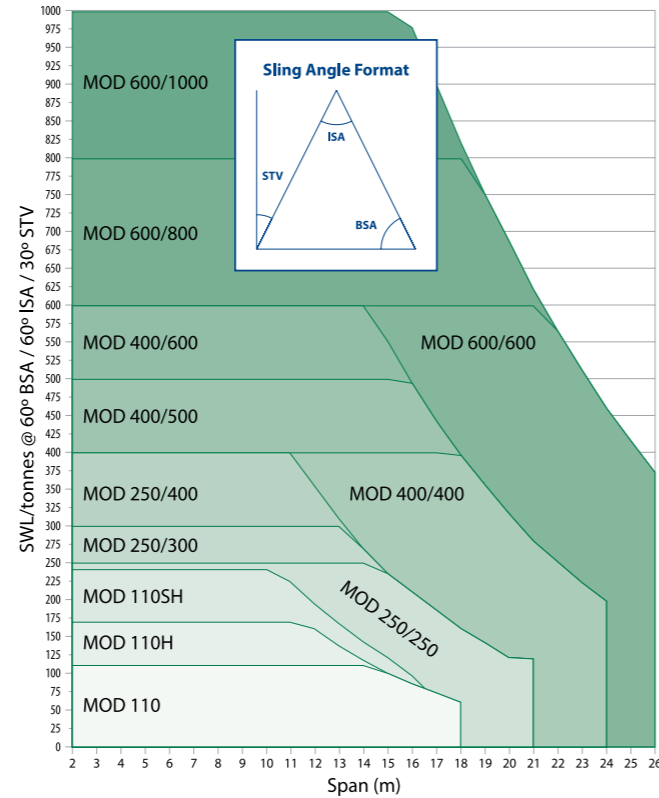

WEIGHT PER SET (KGS) * Weight based on heaviest spreader in series using configuration recommended in user instructions

Weight	MOD 6	MOD 12	MOD 24	MOD 34	MOD 50	MOD 70/H	MOD 110/H	MOD 110SH	MOD 250	MOD 400	MOD 600
Max. Component Weight	8.1	19	41	51	140	240	367	444	860	165	2665
Min. Component Weight	0.6	1.3	5	7	11	17/32	4/45	63	90	135	135
Weight at Max. Span	32	75	178	290	532	972/1090	1970/2130	2628	4895	8260	17260

WHAT SIZE SHACKLE DO I NEED?

STANDARD RANGE

MOD 34
Top: 25t
Lower: 17t

MOD 6
Top: 4.75t
Lower: 3.25t

MOD 12
Top: 8.5t
Lower: 6.5t

MOD 24
Top: 17t
Lower: 12t

MOD 50
Top: 35t
Lower: 25t

MOD 70/H
Top: 55t/85t
Lower: 35t/55t

HEAVY RANGE

MOD 110/H/SH
Top: 85t/120t/150t
Lower: 55t/85t/120t

MOD 250
Top: 200t-300t
Lower: 125t-200t

MOD 400
Top: 300t-400t
Lower: 200t-400t

MOD 600+
Top: 300t-600t
Lower: 200t-500t

STANDARD RANGE - COMPONENTS PER SET * Please note: Custom length Struts are available on request

Spreader System	Strut												End unit	Drop link	
	0.1m	0.2m	0.25m	0.3m	0.5m	0.6m	0.75m	1.0m	1.5m	2.0m	3.0m	4.0m			6.0m
MOD 6	1	1		1		1		4						2	2
MOD 12			1		1		1	1	3					2	2
MOD 24					1			1		3				2	2
MOD 34					1			1		4				2	2
MOD 50					1			2		1		2		2	2
MOD 70/70H					1			1		2		2		2	2
MOD 110/110H					1			1		2		3		2	2
MOD 110SH					1			1		1		3		2	2
MOD 250-250/250-300/250-400					1			1		2	1		2	2	2
MOD 400-400/400-500/400-600					1			1		1	1		3	2	2
MOD 600-600/600-800/600-1000					1			1		1	1		3	2	2

MATERIAL HANDLING

- SKOOTS
- GANTRIES
- SHEAR LEGS
- CRANE FORKS
- FLOOR CRANES
- PALLET TRUCKS
- ROUSTABOUTS
- VACUUM LIFTS
- MACHINE SKATES
- SHIFTA CONVEYOR
- SPREADER BEAMS
- BLOCK/KERB GRABS
- MATERIAL LIFTS
- BUMPA/HODDI HOIST
- POWERED STAIR CLIMBER
- GLASS HANDLING MACHINES
- TRACKED CARRIER



GANTRIES		Product Link
	0.5t - 20t SWL	<ul style="list-style-type: none"> Slings Hand Operated Chain Hoist Electric Chain Block Portable Hoist, Air Hoist Girder Clamps, Girder Trolleys
	Adjustable in height and width	
	Report of Thorough Examination Supplied	
	Ideal for use where space is at a premium	

ALUMINIUM GANTRIES		Product Link
	Up to 5t SWL	<ul style="list-style-type: none"> Slings Hand Operated Chain Hoist Electric Chain Block Portable Hoist, Air Hoist Girder Clamps, Girder Trolleys
	Adjustable in height	
	Lightweight	
	Various beam lengths available 3m to 6m span	
	Report of Thorough Examination Supplied	

RAPIDE GANTRIES		Product Link
	Upto 500kg	Load bearing, lockable castors for easy positioning
	Adaptable, multi-purpose trolleys	Report of thorough Examination supplied
	Rapid assembly by one person in less than a minute	Can be used as a rescue frame see page 52 for more information
	Winch options available	Harness and lanyard

SHEAR LEGS		Product Link
	0.5t - 3t SWL	<ul style="list-style-type: none"> Chain Slings Shackles Hand Operated Chain Hoist Electric Chain Hoist
	Adjustable in height and width	
	Report of Thorough Examination Supplied	

TRACKED CARRIERS

The 1200 series Tracked Carriers are the ideal all-round carriers. At just 750mm wide the 1200 R and 1200 PRO models can fit through most doorways, and with a substantial 1,200kg maximum capacity the uses are endless.

Tracked Carriers R models use state-of-the-art technology whilst being simple to operate, reliable and easy to maintain. PRO models offer increased features such as gradient monitoring, information feedback and a smart auxiliary output, ideal when increased safety measures are required or powered attachments make the job easier.

- Power (max) 2.4kW
- Battery capacity 115Ah
- Charger input 110v-230v
- Max capacity on level ground 1200kg on page 17

	R Model	Pro Model
Efficient direct AC electric drive	■	■
Fully proportional remote control	■	■
Maintenance free AGM batteries	■	■
Hazard lights front and rear	■	■
Switchable motion alarm	■	■
On board diagnostics	■	■
Adaptable and extendable platform	■	■
LCD information screen on remote control	—	■
Smart auxiliary output socket	—	■
Automatic gradient/speed monitoring	—	■
Non-marking tracks	□	□
Wide range of attachments	□	□

■ Standard □ Optional



REID PORTAGANTRY

REID PORTAGANTRY 500-5000

Dimensions [mm]

WLL [kg]	Frame size [Product Code]	DMax Height to lifting eye	E Height increment	DMin Height to lifting eye	F Height to top of beam	HMax Height to top of roller	HMin Height to top of roller	G Width	A-Frame weight [kg] (approx)	Trolley roller size	Castor Diam
500	PGAS00500S	2355	5 x 150	1605	2675	2757	2007	1212	32	82	150
	PGAS00500M	2851	5 x 150	2101	3171	3253	2503	1429	42	82	150
	PGAS00500I	3188	5 x 200	2188	3499	3581	2581	1726	50	82	200
	PGAS00500T	4079	6 x 200	2879	4399	4481	3281	2011	56	82	200
	PGAS00500TC4	4527	6 x 200	3327	4847	4930	3730	2234	86	82	200
	PGAS00500TC3	5027	6 x 200	3827	5347	5430	4230	2557	91	82	200
	PGAS00500TC2	5527	8 x 200	3927	5848	5930	4330	2733	97	82	200
PGAS00500TC1	5829	9 x 200	4029	6149	6231	4431	2733	102	82	200	
1000	PGAS01000S	2355	5 x 150	1605	2675	2757	2007	1212	32	82	150
	PGAS01000M	2851	5 x 150	2101	3171	3253	2503	1429	42	82	150
	PGAS01000I	3188	5 x 200	2188	3499	3581	2581	1726	50	82	200
	PGAS01000T	4079	6 x 200	2879	4399	4481	3281	2011	56	82	200
	PGAS01000TC4	4527	6 x 200	3327	4847	4930	3730	2234	86	82	200
	PGAS01000TC3	5027	6 x 200	3827	5347	5430	4230	2557	91	82	200
	PGAS01000TC2	5527	8 x 200	3927	5848	5930	4330	2733	97	82	200
PGAS01000TC1	5829	9 x 200	4029	6149	6231	4431	2733	102	82	200	
2000	PGAS02000S	2355	5 x 150	1605	2675	2757	2007	1212	35	82	150
	PGAS02000M	2851	5 x 150	2101	3171	3253	2503	1429	42	82	150
	PGAS02000I	3188	5 x 200	2188	3499	3581	2581	1726	50	82	200
	PGAS02000T	4079	6 x 200	2879	4399	4481	3281	2011	56	82	200
	PGAS02000TC4	4527	6 x 200	3327	4847	4930	3730	2234	86	82	200
	PGAS02000TC3	5027	6 x 200	3827	5347	5430	4230	2557	91	82	200
	PGAS02000TC2	5527	8 x 200	3927	5848	5930	4330	2733	97	82	200
PGAS02000TC1	5829	9 x 200	4029	6149	6231	4431	2733	102	82	200	
3000	PGAS03000S	2410	5 x 150	1660	2730	2812	2062	1212	56	82	200
	PGAS03000M	2906	5 x 150	2156	3226	3308	2558	1429	61	82	200
	PGAS03000I	3188	5 x 200	2188	3499	3581	2581	1726	73	82	200
	PGAS03000T	4079	6 x 200	2879	4399	4481	3281	2011	85	82	200
	PGAS03000TC4	4527	6 x 200	3327	4847	4930	3730	2234	86	82	200
	PGAS03000TC3	5027	6 x 200	3827	5347	5430	4230	2557	91	82	200
	PGAS03000TC2	5527	8 x 200	3927	5848	5930	4330	2733	97	82	200
5000	PGAS05000IR	3181	5 x 200	2181	3592	3717	2717	1736	99*	125	200
	PGAS05000TR	4049	6 x 200	2849	4487	4612	3412	2021	109*	125	200
	PGAS05000TC4R	4500	6 x 200	3300	4938	5062	3862	2234	96	125	200
	PGAS05000TC3R	5000	6 x 200	3800	5438	5562	4362	2557	101	125	200

S & M versions also available as custom systems | WLL 5000kg dimensions systems are shown using the deeper 'D' section beam

Dimensions use standard Master Link Trolley, other options available to increase resulting height of lift (HoL) and to assist with load movement.
*Weight includes stabiliser legs

- A Beam length
- B Beam adjustment
- C Clear operating span
- D Height to lifting eye
- E Height increment
- F Height to top of beam
- G Width
- H Height to top of roller

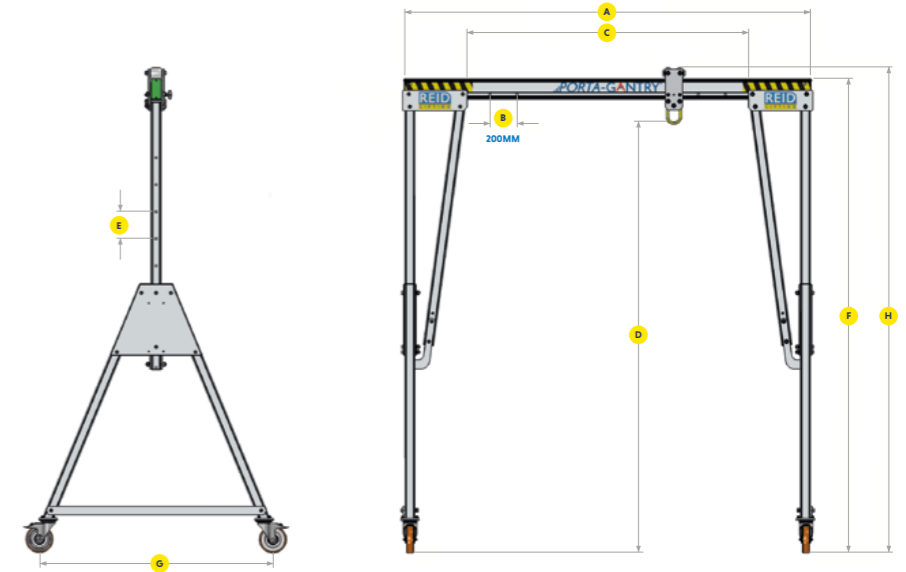

		Standard Beam Length A[mm] (Clear Operating Span C = A - 920 mm)							
A [mm]		2500	3000	3920	4570	5500	6000	8400	9000
C [Min] [mm]		1180	1680	2200	2050	2980	3480	5880	6480
C [Max] [mm]		1580	2080	3000	3650	4580	5080	7480	8080
WLL Rating [kg]	500	19	22	29	34	41	44	62	66
1000	19	22	29	34	41	44	79	84	
2000	19	22	29	34	52	93*	130*	x	
3000	19	22	37	43	85*	93*	130*	x	
5000	39*	47*	61*	71*	85*	x	x	x	

Weight of Beams [kg]

*Clear operating span for D section beams is C = A - 910mm.
To ensure stability of the structure, the operating span of the beam must be equal to or greater than the distance between the castors on the A-frame



GML 800+ M-SERIES MATERIAL LIFT

- High safe working loads, versatile applications, ease of operation and durability are some of the most important aspects in the development of the GML800+ range.
- Manual winch, each with worm gear for powerful use or small use of force when cranking.
- The GML800 + series is constructed such that the outriggers can be mounted to the front and to the rear on the chassis. This allows to combine the lift on respective use and local conditions individually

GML 800+ IS AVAILABLE IN

M-Serie	GML800+ /10/M	GML800+ /15/M	GML800+ /20/M	GML800+ /25/M
Working height - Standard fork up	3.49m	4.98m	6.46m	7.94m
Transport position - height/length/width	1.98/1.00/0.78m	1.98/1.00/0.78m	1.8/1.00/0.78m	1.98/1.00/0.78m
Working position - height/length/width	1.98/1.94*/0.78m	1.98/1.94*/0.78m	1.98/1.94*/0.78m	1.98/1.94*/0.78m
Safe working load (load centre at 28 cm)	900kg	850kg	850kg	800kg
Weight Chassis + outriggers	237kg	260kg	293kg	316 kg
Weight - counterbalance weights + box	207kg	207kg	207kg	207kg



MATERIAL LIFTS

- Up to 454kg SWL
- Lifting heights available up to 25 feet
- One person operation
- Report of Thorough Examination Supplied

Product Link

- Pallet Trucks
- Bogeys
- Boom Extension
- Drum Support Attachment
- Platform Attachment
- Extension Forks



COUNTER BALANCE MATERIAL LIFT

Available in load of 300kg - 450kg	Ground Clearance, working position - 0.8m
Height lifting upto - 6.90m	Loading height minimum- 0.27m
Height Stowed upto - 2.04m	Payload - 300kg
Length Stowed upto - 1.02m	Weight basic chassis - 204kg
Width Stowed upto - 0.80m	Weight complete - 332kg
Working position - 2.20m	

MATERIAL LIFT ATTACHMENTS *SWL Reduction at various points - Please ask for details



Boom extension*



Drum support attachment



Platform attachment



Extension forks*









ROUSTABOUT MATERIAL LIFTS



- Up to 680kg SWL
- Lifting height up to 7500mm
- Dual speed winch
- One person operation
- Report of Thorough Examination Supplied



Product Link



- Pallet Trucks
- Bogeys



	PALLET TRUCKS	Product Link
	Up to 3t SWL	 Skoots Bogeys  Rack and Pinion Hoist
	Highly versatile	
	Robust construction	
	Long reach models available	
Report of Thorough Examination Supplied		



	FORK LIFT EXTENDABLE JIB	Product Link
	Up to 5t SWL	 Skoots Bogeys  Rack and Pinion Hoist
	Extension range up to 3700mm	
	Easy installation	
	Report of Thorough Examination Supplied	



	ALL TERRAIN PALLET TRUCKS - Powered and Manual	Product Link
	Up to 1.5t SWL	 Skoots Bogeys  Rack and Pinion Hoist
	Ideal for uneven surfaces	
	Report of Thorough Examination Supplied	

	POWERED PALLET TRUCKS	Product Link
	Up to 2t SWL	 Skoots Bogeys  Rack and Pinion Hoist
	110V/240V charge	
	Labour saving	
	Report of Thorough Examination Supplied	

	POWERED PEDESTRIAN OPERATED STACKER TRUCKS	Product Link
	Up to 1.2t SWL	 Skoots Bogeys  Rack and Pinion Hoist
	110V/240V charge	
	Labour saving	
	Report of Thorough Examination Supplied	

	FORK LIFT ATTACHMENTS	Product Link
	Up to 5t SWL	 Chain Slings Slings Shackles
	Highly versatile	
	Easy installation	
	Report of Thorough Examination Supplied	

	RUBBLE TRUCK	Product Link
	Max Load 750kg	 Chain Slings Shackles  Rack and Pinion Hoist
	Measures 750mm (w) x 1530mm (l) x 930mm (h)	
	400Litre Volume	
	Total weight (empty) 67kg	
Report of Thorough Examination Supplied		

	COUNTER-BALANCED HYDRAULIC FLOOR CRANES	Product Link
	0.25t - 1t SWL	 Portable Hoist Hand Operated and Electric Chain Blocks  Slings Shackles
	Telescopic lifting points	
	Highly manoeuvrable	
	Report of Thorough Examination Supplied	

	OUT-RIGGED HYDRAULIC FLOOR CRANES	Product Link
	0.25t - 3t SWL	<ul style="list-style-type: none"> Portable Hoist Hand Operated and Electric Chain Blocks Slings Shackles
	Highly versatile	
	Telescopic lifting points	
	Report of Thorough Examination Supplied	

	MACHINE MOVING SKATES	Product Link
	6t - 100t capacity	<ul style="list-style-type: none"> Pallet Trucks Skoots Pulling Machines Hydraulic Pulling Machines Winches
	Available in caterpillar, roto and nylon models	
	Easy to use	
	Low headroom	
Report of Thorough Examination Supplied		

	2 & 4 WHEEL BOGEYS	Product Link
	Up to 2t SWL	<ul style="list-style-type: none"> Pallet Trucks Skoots Pulling Machines Hydraulic Pulling Machines Winches
	Turntable operation	
	Varying platform size	
	Flat top and V-shape 2 wheel bogeys also available	
Report of Thorough Examination Supplied		



	STAIR CLIMBING TROLLEYS/SACK TRUCKS	Product Link
	Up to 0.35t SWL	<ul style="list-style-type: none"> 4 Wheel Bogeys Pallet Trucks
	Highly versatile	
	Report of Thorough Examination Supplied	<ul style="list-style-type: none"> Slings Shackles



	POWERED STAIR CLIMBERS	Product Link
	Up to 680kg SWL	<ul style="list-style-type: none"> 4 Wheel Bogeys Pallet Trucks
	Battery powered	
	One man operation	
Report of Thorough Examination Supplied		

	PANEL TROLLEYS	Product Link
	Up to 1t SWL	<ul style="list-style-type: none"> Rack and Pinion Hoist Chain Slings
	Robust construction	
	For use with glass or flat sheet materials	
	Report of Thorough Examination Supplied	

	SKOOTS	Product Link
	Up to 5t SWL	<ul style="list-style-type: none"> 4 Wheel Bogeys Pallet Trucks
	Hydraulic operation	
	Highly manoeuvrable	
Report of Thorough Examination Supplied		



	CRANE FORKS	Product Link
	Up to 2t SWL	<ul style="list-style-type: none"> Slings Shackles Crane Hire
	Adjustable in height and width	
	Supplied with a rated safety net	
	Tapered forks for easy pallet pick-up	
Report of Thorough Examination Supplied		



	GAS BOTTLE CARRIER		Product Link
	Up to 6 bottle capacity		 Slings Shackles
	Safe method of lifting		 Crane Hire
	Report of Thorough Examination Supplied		





	SHIFTA - PORTABLE CONVEYOR		Product Link
	Ideal for use with stones, aggregate, soil, concrete etc		 Skip Lifting Cradle
	Maximum payload 150kg		
	5kva 110v transformer will run four linked machines		
	Max angle 50° depending on material (eg. Stones, aggregate, soil)		
	In built belt tracking and scraper (scraper front and back)		
	Detachable hopper		
Report of Thorough Examination Supplied			



	BUMPA/HODDI HOIST		Product Link
	Up to 10m operation		 Bogeys Pallet Trucks Starke Bin
	110V availability		
	Easy Installation		
	Hoddi buckets available to hire/purchase		
Report of Thorough Examination Supplied			



	GLAZING ROBOT - SL 608		Product Link
	Up to 600kg SWL		 Bogey Pallet Trucks Panel Trolley
	Max working height 4200mm		
	Indoor & outdoor options		
	Range of models available		
Report of Thorough Examination Supplied			

	GEDA 200Z VERTICAL MATERIAL HOIST		Product Link
	200kg SWL		 Bogey Pallet Trucks Panel Trolley
	Max height of lift 35mtr with option of multiple landing gates		
	1.5x 1.5mtr base footprint		
	Report of Thorough Examination Supplied		
Report of Thorough Examination Supplied			

	GEDA LIFT 250 INCLINED MATERIAL HOIST		Product Link
	250kg SWL		 Bogey Pallet Trucks Panel Trolley
	Max height of lift 19mtr		
	Range of load attachments: Adjustable Platform, Tipping Skip, Sheet Carrier		
	Report of Thorough Examination Supplied		
	Hydraulic lifting and tilting powered by 12v battery pack		
Not suitable for use in the rain			

	POWERED VACUUM		Product Link
	Up to 1000kg SWL		 Slings Shackles  Chain Blocks Builders Hoist  G20 Pick and Carry Crane Mini Spider Crane Crane Hire
	Various sizes available		
	Loss of vacuum alarm		
	Report of Thorough Examination Supplied		
	MRTA2		
	MRTA6		
MRTA8			

	GLASSBOY 330 & 500		Product Link
	SWL 330kg/500kg		 Slings Shackles  Portable Hoists
	Max height of hook 2.7m		
	Hydraulic lifting arm		
	Hoist not included		
Report of Thorough Examination Supplied			

	BIGFOOT	Product Link
	SWL 280kg	 Slings Shackles  Bogey Pallet Trucks Panel Trolley
	Max height of hook 2.6m	
	Rough terrain wheels	
Report of Thorough Examination Supplied		

	CONCRETE PIPE LIFTER
	Designed for the safe lifting of pipes from transport vehicles to the placement within trenches.
	The RVD-4 can be attached to any lifting device with a quick change facility.
	Capable of lifting one pipe up to 4,000kg and with diameters of between 300mm to 1.200mm.
	Carrying Capacity - 4000kg SWL
Gripping Range - 300mm -1200mm	
For use with suitable plant (Quick hitch operation)	

	VACUUM LIFTING EQUIPMENT VH1	Product Link
	Carrying capacity 25kg and 50kg SWL	 Pallet Trucks Bogeys
	One person operation for lightweight slabs and short transportation distance	
Two person operation upto 50kg		

	VACUUM LIFTING EQUIPMENT - SH1000	Product Link
	Carrying capacity 1000kg SWL	 Pallet Trucks Bogeys
	Petrol powered	
Various suction plates available for use with suitable plant		

	VACUUM LIFTING EQUIPMENT - SH2500	Product Link
	Carrying capacity 2500kg SWL	 Pallet Trucks Bogeys
	Petrol powered	
Various suction plates available for use with suitable plant		

	KERB AND SLAB LIFTING EQUIPMENT - BZ KERB HANDLES	Product Link
	Carrying capacity 50kg	 Pallet Trucks Bogeys
	Gripping range 0mm - 400mm	
	One and two person lifting handles	
Not Supplied as a pair		

	BVZ UNIVERSAL HANDLE	Product Link
	Carrying capacity 50kg	 Pallet Trucks Bogeys
	Gripping range 0mm - 550mm	
Two person operations		



	VZ1 KERB STONE HANDLE	Product Link
	Carrying capacity 100kg	 Pallet Trucks Bogeys
	Gripping range 500mm - 1045mm	
	Two person operations	
For use with suitable plant		

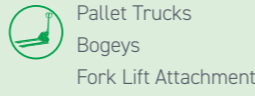

	EXG EASY GRIP STONE HANDLE	Product Link
	KERB AND SLAB LIFTING EQUIPMENT	 Pallet Trucks Bogeys Fork Lift Attachment
	Carrying capacity 500kg swl	
	Gripping range 0mm - 300mm	
	Two person operations	
For use with suitable plant		

	TSV STEP HANDLES	Product Link
	KERB AND SLAB LIFTING EQUIPMENT	 Pallet Trucks Bogeys Fork Lift Attachment
	Carrying capacity 250kg swl	
	Gripping range 70mm - 500mm	
	Two person operations	
For use with suitable plant		

	TSZ UNI STEP HANDLES	Product Link
	KERB AND SLAB LIFTING EQUIPMENT	 Pallet Trucks Bogeys Fork Lift Attachment
	Carrying capacity 600kg swl	
	Gripping range 50mm - 600kg swl	
	For use with suitable plant	



	FTZ UNI 15 CONCRETE GRAB	Product Link
	KERB AND SLAB LIFTING EQUIPMENT	 Pallet Trucks Bogeys Fork Lift Attachment
	Carrying capacity 1500kg	
	Gripping range 0mm - 750mm	
	For use with suitable plant	

	FTZ UNI 50 CONCRETE GRAB	Product Link
	KERB AND SLAB LIFTING EQUIPMENT	 Pallet Trucks Bogeys Fork Lift Attachment Crane Hire
	Carrying capacity 5000kg swl	
	Gripping range 0mm - 850mm	
	For use with suitable plant	

	SVZ UNI MANHOLE RING INSTALLATION CLAMP	Product Link
	PIPE & MANHOLE LIFTING EQUIPMENT	 Pallet Trucks Bogeys Fork Lift Attachment Crane Hire
	Carrying capacity 2500kg swl	
	Gripping range 900mm - 1800mm (complete with adaptors)	
	For use with suitable plant	

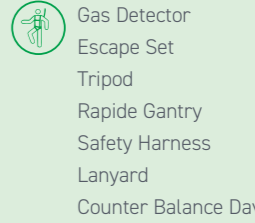

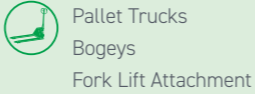
	SRG UNI MANHOLE RING CLAMPS	Product Link
	PIPE & MANHOLE LIFTING EQUIPMENT	 Pallet Trucks Bogeys Fork Lift Attachment Crane Hire
	Carrying capacity 1500kg and 3000kg	
	1500kg gripping range 400mm - 1200mm	
	3000kg gripping range 600mm - 1800mm	
For use with suitable plant		

	SDH-H MANHOLE COVER LIFTER	Product Link
	PIPE & MANHOLE LIFTING EQUIPMENT	 Gas Detector Escape Set Tripod Rapide Gantry Safety Harness Lanyard Counter Balance Davit
	Carrying capacity 1500kg swl	
	2-4 key cover lifter	
	Manual operation	

	RG5-150 ROUND PIPE GRAB	Product Link
	PIPE & MANHOLE LIFTING EQUIPMENT	
	Carrying capacity 5000kg	 Pallet Trucks Bogeys Fork Lift Attachment
	Gripping range 600mm - 1500mm	 Crane Hire
	For use with suitable plant	

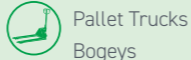
	SG40 - SG80 SCISSOR GRAB	Product Link
	Carrying capacity 1800kg	 Pallet Trucks Bogeys Fork Lift Attachment
	Gripping range 500mm - 1100mm	 Crane Hire
	For use with suitable plant (fork sleeve attachment available)	
	Supplied with a rated safety net	

	BZSH SITE FENCE BLOCK LIFTER	Product Link
	Carrying capacity 35kg	 Pallet Trucks Bogeys
	One or two person operation	
	For use with suitable plant	

	H-FVZ BOULDER GRAB	Product Link
	Carrying capacity 200kg swl	 Pallet Trucks
	Gripping range 0mm - 600mm	
	Two person operation	
	For use with suitable plant	

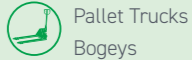
	VTK-V BLOCK CART	Product Link
	Carrying capacity 400kg swl	 Pallet Trucks Bogeys
	Gripping range 550mm - 1050mm	
	One person operation	

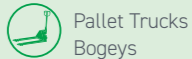
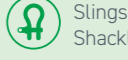
	VPH150	Product Link
	Upto 150kg swl	 Pallet Trucks Bogeys
	12V battery powered vacuum lifter for both slabs and kerbs	 Slings Shackles
	Wheel kit available	
	Various suction plates available	

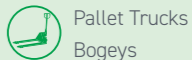
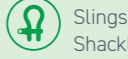
	STONE MAGNET	Product Link
	Carrying capacity 400kg swl	 Pallet Trucks Bogeys
	Gripping range 0mm - 550mm	 Slings Shackles
	For use with suitable plant	
	Various suction plates available	
	Wheel kit available	

SAFETY

- SAFETY HARNESSSES
- LANYARDS
- FALL ARREST DEVICES
- RAPIDE GANTRIES - CONFINED SPACE







Our dedicated Safety & Communications depots can also provide escape sets, gas detectors, defibrillators, winches and much more. Just visit www.sunbeltrentals.co.uk for further info.



	<p>SAFETY HARNESSSES</p> <p>Fully adjustable harnesses</p> <p>Full range available</p> <p>Arrest and restraint lanyards available</p> <p>Fully compliant with PPE regulations</p> <p>Report of Thorough Examination Supplied</p> <p>Accreditation to EN361</p>	<p>Product Link</p> <p> Fall Arrest Device Man-Riding Shear Legs Man-Riding Davit Lanyards Rapide Gantry</p>
	<p>LANYARDS</p> <p>Available in restraint or shock absorber designs</p> <p>Various connectors available</p> <p>Standard length 2m</p> <p>Single or twin leg available</p>	<p>Product Link</p> <p> Harnesses Escape Sets Gas Detector Horizontal Safety Line</p>
	<p>FALL ARREST DEVICE</p> <p>Available up to 30m</p> <p>Fail safe locking mechanism</p> <p>Robust and compact</p> <p>Report of Thorough Examination Supplied</p>	<p>Product Link</p> <p> Man-Riding Shear Legs Safety Harness Mobile Man Anchor Rapide Gantry</p>
	<p>RAPIDE GANTRIES - CONFINED SPACE</p> <p>Personnel WLL up to 250kg</p> <p>3 Person Fall Arrest to EN795:1997</p> <p>Certified as part of an EN363 compliant system.</p> <p>Atex: Suitable for use in ATEX Zone 2 explosive atmosphere</p> <p>Lightweight and Portable</p> <p>Within Manual Handling Guidelines weighing only 33kg</p> <p>Report of Thorough Examination supplied</p>	<p>Product Link</p> <p> Harnesses Escape Sets Gas Detector Horizontal Safety Line</p>





LOAD MEASUREMENT





- DIGITAL LOAD INDICATORS
- COMPRESSIVE LOAD INDICATORS
- TEST WEIGHTS
- TEST CRADLES



	DIGITAL LOAD INDICATORS	Product Link
	Up to 100t SWL	
	Remote readout available	 Shackles
	Compact and lightweight	 Hoisting
	Accuracy: ± 0.2% of nominal capacity	 Winching
	Report of Thorough Examination Supplied	

	COMPRESSIVE LOAD INDICATORS	Product Link
	Up to 100t SWL	
	Hand held readout	 Pump Hose Manifolds Gauge
	Robust and compact	
	Report of Thorough Examination Supplied	

	TEST WEIGHTS	Product Link
	Wide range available	 Slings
	Transportation supplied	 Digital Load Indicator
	Report of Thorough Examination Supplied	 Pallet Trucks Bogeys Stillages

	TEST CRADLES	Product Link
	Wide range available	 Slings
	Full specifications upon request	 Digital Load Indicator
	Report of Thorough Examination Supplied	 Pallet Trucks

	WEIGHT STILLAGE AND TROLLEY
	Designed to enable the user to easily move weights around and greatly reduce the level of manual handling required
	Each stillage can hold 4 no 20kg weights and added to the self-weight of the stillage totals 100kg
	Each stillage with weights can then be transported by the trolley and positioned where required eliminating any carrying of the weights
	For most hires only one trolley would be required and the respective number of weights and stillages to achieve the required total weight requirement by the customer
	Commonly used for all types of testing work

HEAVY LIFT AND CRANE HIRE

- CRANE ACCESSORIES
- CRANE HIRE
- LOAD WEIGHING EQUIPMENT
- HEAVY DUTY SLINGS
- LIFTING BEAMS
- MODULAR BEAMS AND ACCESSORIES
- SHACKLES



We are proud to offer a variety of **Heavy lift and Crane Accessories, including industry changing Modulift Spreader and Lifting Beam range that can offer lifting solutions up to 1000 tonne SWL.**

Our range of Heavy Lift equipment is immediately available for hire or supply and our team of experts can carry out site surveys to help find solutions to overcome any Heavy Lift challenge our customers may face.











OUR RANGE OF ACCESSORIES INCLUDE:

- Modular spreader beams up to 1000t
- CMOD Lifting Frame up to 250t
- Widebody shackles up to 500t
- Wire ropes/grommits 600t
- Dyneema ropes and slings
- Crane accessories and mats
- Active Link drop links with data logging available





OUR SERVICES INCLUDE:







- Bespoke design and manufacture of lifting beams/ accessories
- Advice on rig planning and full
- Site Surveys

	G20 PICK AND CARRY CRANE		Product Link
	Up to 2t SWL		 Portable Hoists  Electric Hoists
	Small and compact		
	Report of Thorough Examination Supplied		 Slings  Shackles
	Ideal for Curtain Wall installation		
Battery powered			

	SPIDER MINI-CRANES		Product Link
	Up to 1t SWL or four men		 Digital Load Indicator
	Compliant to current legislation		
	Report of Thorough Examination Supplied		 Slings  Shackles

	CRANE LIFTING ACCESSORIES	
	Up to 100t SWL	
	Conventional and all terrain specifications	
	Site survey available upon request	
	Banksman/riggers and appointed person supplied if required	
Report of Thorough Examination Supplied		

	CRANE SKIPS		Product Link
	Up to 2000L		 Crane Hire
	Master flow, geared, rollover and funnel types available		
	Report of Thorough Examination Supplied		 Slings  Shackles

	MAN-RIDING AND STRETCHER CRADLES		Product Link
	Up to 1t SWL or four men		 Harness  Escape sets
	Variety of sizes/models available		
	Compliant to current legislation		 Crane Hire  Slings  Shackles
	Report of Thorough Examination Supplied		



Want to buy?
 Email Liftenquiries@sunbeltrentals.co.uk

BESPOKE DESIGNS AND SOLUTIONS

Sunbelt Rentals is able to arrange the design, manufacture and supply of a wide variety of lifting equipment, working with expert supply partners to ensure our customers get the highest quality and safest equipment every time.

We are always looking for innovation, to develop and adopt new lifting equipment to assist our customers. By working with our expert supply partners, all designs are fully supported by technical files with design calculations and drawings and we have worked alongside many of the UK leading names in Construction, Glass panel installation and Structural engineers.

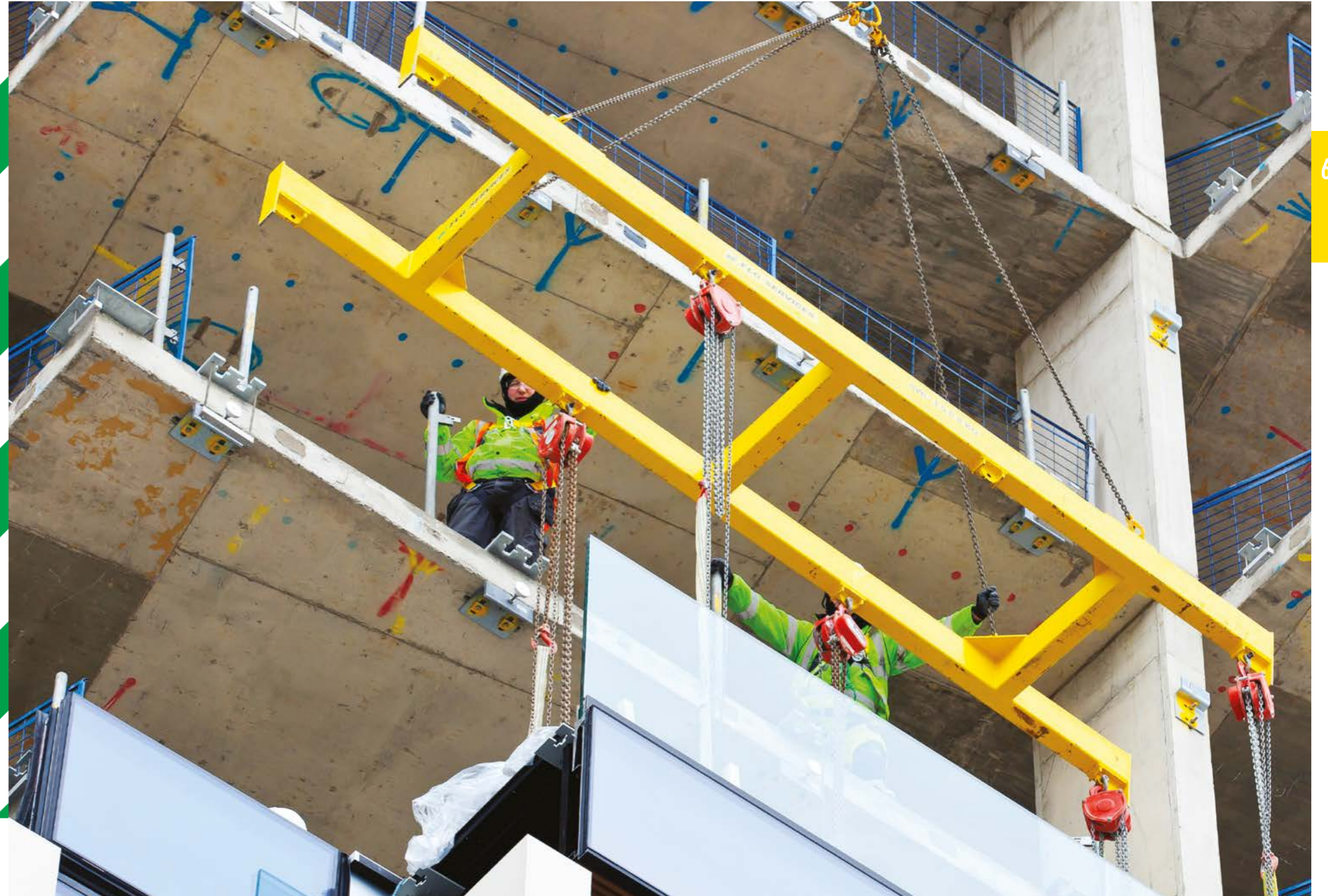

CASE STUDIES

Client MGA Northwest Limited
Project Name Birkenhead Bridge
Location Birkenhead, Wirral

THE CHALLENGE

This was a high profile project as there was significant disruption to the travelling public during the dismantling work. The route between Wallasey and Birkenhead is ordinarily very busy and there was no through route along Tower Road during the works, so time was of the essence. The bridge needed to be lifted by a floating crane and lifted over 300 metres to the quayside. With uncertainty relating to the exact weight of the bridge, Sunbelt Rentals were tasked with supplying over 400 tonne of lifting tackle to complete this challenging lift.

THE SOLUTION

Following an assessment of the lift based on the customer's plan, Sunbelt Rentals provided a comprehensive list of all the products and accessories needed to complete the lift successfully. This comprised a floating crane capable of lifting the structure and carrying it across to the quayside. The product range supplied by Sunbelt Rentals included a 400 Tonne Modular Beam, 250 Tonne Dyneema Round Slings, 110H Modular Beams, 58 Tonne Wire Rope Slings, 55 Tonne Collar Chains and Widebody Shackles. Due to the heavy weight of the dismantled steel bridge, Health and Safety was the ultimate priority and Sunbelt Rentals' expertise in the lifting sector was absolutely critical.

SUNBELTRENTALS.CO.UK FOR MORE INFO

THE RESULTS

The lift was successfully completed in a single day with all lifting equipment supplied by the local Sunbelt Rentals service centre in Liverpool. This project showcased Sunbelt Rentals' investment in heavy lifting equipment, and our expertise in completing demanding lifts.



Client Osprey Ltd
Project Name Water for Maiden Voyage
Partner Supplier Modulift

THE CHALLENGE

Osprey accepted a scope of work from shipbuilder Wight Shipyard to move the vessel from the shed where it was built to the water at Venture Quays, Cowes on the Isle of Wight, before a course was set for its final destination in Austria. The 250-passenger Twin City Liner is 39.7m long, 11.1m wide, and 6.8m high.

The first challenge was removing the vessel, which is due to arrive in Vienna in time for the start of the new season at the end of March 2019 from its building. Osprey selected two, six-axle Goldhofer self-propelled modular transporters (SPMT) to work in tandem to move the load to within the reach of the Liebherr LTM1800D. The crane was complete with a 36m high rig, designed to accommodate a 3.7m centre of gravity offset and different elevations of the boat's lifting eyes.

THE SOLUTION

A Modulift MOD400 was used at a 29m span beneath 29m long and 26.4m long top slings to balance the lift, these Dyneema and polyester slings also provided by Sunbelt Rentals. Two MOD70H beams were used underneath, one at 5.5m long and the other at 4m. Again, two different lengths of sling were used to connect them to the top beam—3m at the stern (back) and 3.9m at the bow (front). The slings that met the lifting eyes at the bottom of the rig were all 4m in length.

Danny Skidmore, heavy cranes manager at Osprey, said: "We had to work closely with shipbuilders and naval architects, and refer to CAD (computer-aided design), to devise a method of lifting the catamaran safely and completely level. The previous time we lifted such a vessel, we used two cranes in tandem, but mobilising two cranes of that size represents a large-scale operation and high costs, not to mention the disruption it has on the shipyard. We wanted to come up with a way to minimise mobilisation and limit the impact on our client's busy, marine environment."



CASE STUDIES

Client NG Bailey
Project Name Custom Electric Stackers
Location The Forge, 105 Sumner Street, London

NG Bailey is the UK's leading independent engineering and services business, bringing buildings and infrastructure to life. One of their latest projects is a multi-level development in Central London called The Forge. The Forge is two new-build commercial office buildings, built around a publicly accessible internal courtyard, in total comprising c. 139,000 sq ft. It will be nine storeys high with reception and basement areas. The development will be a high quality and sustainable building with a vastly improved streetscape and public realm. NG Bailey approached Sunbelt Rentals during the early stages of the project to support with developing a solution to safely lift and install pre-assembled modules. The modules were manufactured off-site and contained all of the electrics and pipework needed during the construction of the development.

THE CHALLENGE

NG Bailey had initially planned on using standard stackers to lift the modules into place, however this presented a number of challenges. The stackers needed to be a net weight of less than 2,000 kg to be transported using a goods lift between floors. Standard forks wouldn't be long enough to lift the modules into position, however adding extension forks would have gone against the manufacturer's recommendation, so wasn't an option.

[SUNBELTRENTALS.CO.UK](https://www.sunbeltrentals.co.uk) FOR MORE INFO

▲ With a challenging set of project constraints, it was great to see Sunbelt Rentals understood our needs both on paper and on site. Since using the custom stackers, we have increased our module installation productivity and made the installation process safer due to the extended forks. ▲

Chris Baggley,
Project Engineer,
NG Bailey

THE SOLUTION

Working closely with our supplier, SHS Handling, Sunbelt Rentals developed and engineered a custom solution, an extended fork electric stacker. The weight of these custom designed stackers was kept below 2,000 kg so they could use the goods lifts on site, they also gave NG Bailey maximum clearance between the forks and mast so the modules could be positioned correctly. The solution was engineered, manufactured and delivered to site within 12-weeks.

THE RESULTS

Sunbelt Rentals invested in four of the custom designed stackers and supplied them to the site in early September ensuring NG Bailey were able to complete that phase of the project safely, on schedule and without disrupting the wider site. The stackers are now on long-term hire with NG Bailey.





INSPECTION AND TESTING

Sunbelt Rentals are full members of LEEA (Lifting Equipment Engineers Association), giving you peace of mind that all your lifting needs are being met by a team of experienced personnel.

All of our lifting and safety equipment is CE compliant and we also offer a full maintenance and aftersales service for your own equipment, giving you the confidence that your owned equipment is also legally compliant.

Sunbelt Rentals are able to carry out Thorough Examination of fixed and loose lifting equipment on site or at your own premises. Once compliant we can advise you on certification maintenance such as Colour Coding and also give you the capability to review your Reports of Thorough Examination online.

inspections@sunbeltrentals.co.uk
0330 1757 308



PROVIDING RENTAL PRODUCTS AND MANAGED SOLUTIONS INTO EVERY MARKET AND SECTOR



Powered Access

The combined height and reach of our equipment can transport you safely over 50,000 metres



Plant

The widest range of plant including the latest stage v and battery powered machines in the UK



Plant Attachments

The sole UK distributor for several of the world's leading attachment manufacturers



Survey

Industry-leading supplier of land survey and precision measurement technologies



Lifting

Our solutions have been used on 7/10 of the tallest buildings in the UK



Energy

From fuel saving cleaner energy solutions to the latest stage v generators, we have a temporary power solution for every site.



Tools

From battery powered hand tools to compressors, compactors and cleaning equipment we offer a wide range of tool hire that's local to you



Test & Monitoring

Europe's leading test equipment specialists since 1996



Industrial

On your site to meet the demands where every second counts



Utilities

The UK's largest specialist Utility hire company



Safety & Communications

Knowledgeable and experienced specialists in this field



Trakway

Award winning engineered access and ground protection solutions



Traffic Management

24/7 national coverage with operations covered by QEHS accreditations



Barriers & Fencing

Crowd control and perimeter security solutions



Production

From cameras, grip and lighting to backlot infrastructure



Non-Mech

Essentials for every site; fencing, barriers, trenching, ground protection, vehicle and pedestrian control solutions



Rail

We support the Network Rail and Transport for London infrastructure



Hoists

We hold over 10km of mast sections, enough to scale London's Shard building over 32 times



Formwork & Falsework

We are the exclusive hire supplier of MEVA products in the UK



Training

Dedicated Health and Safety training to qualify our own people and our customer's people



Lighting

The UK's largest fleet of state-of-the-art tower lights, including a wide range of solar, hybrid and plug-in options.



Climate Control

Economical and efficient temperature control and HVAC solutions



Accommodation

24/7/365 call out facility covering 20,000 items on fleet

DEPOT CONTACTS AND LOCATIONS

EAST LONDON

Unit D3, Star Business Centre,
Marsh Way, Fairview Industrial Estate,
Rainham, Essex RM13 8UP
0845 872 5605

IPSWICH

Unit 5, Boss Hall Business Park
IP1 5BN
0845 872 5609

WEST LONDON

Unit 1, Abenglen Industrial Estate,
Betam Road, Hayes,
Middlesex UB3 1SS
0845 864 3413

BRIDGWATER

Unit 3, Wylds Road,
Bridgwater, Somerset TA6 4LF
01278 410 755

WEST MIDLANDS

Units A-C, 100 Dudley Road East,
Oldbury, West Midlands B69 3EB
0121 544 1333

EGREMONT

Unit 8, Bridge End, Egremont,
Whitehaven CA22 2RD
01946 823905

MANCHESTER

Jardine Way, Chadderton, Oldham,
Manchester OL9 9QL
0161 745 9237

LIVERPOOL

Unit 10, King Edward Industrial Estate,
Gibraltar Row, Liverpool L3 7HJ
0151 236 2260

SHEFFIELD

Unit 1, Brooklands Business Park
Leigh Street, Sheffield S9 2PR
0114 243 0230

HULL

310 Hawthorn Avenue, Hull HU3 5JF
01482 322120

GRIMSBY

Unit 1, Estate Road No.6,
South Humberside Industrial Estate
North East Lincolnshire DN31 2TG
01472 352 845

GATESHEAD

18D Follingsby Park,
Gateshead, Tyne and Wear NE10 8YF
0191 417 6488

WILTON

Castleton Court, Wilton International,
Redcar, Teesside TS10 4RG
01642 457325

GLASGOW

1 Earl Haig Road, Hillington Park
Glasgow G52 4JU
0141 810 2938

NEWARK

Brunel Drive, Newark NG24 2DE
01636 677 121

FAWLEY

Rigging Loft, Block 3 CMB
Fawley Refinery, Fawley SO45 1TX
02382 148356



Hire
liftingenquiries@sunbeltrentals.co.uk
0330 175 7308

Sales
productsales@sunbeltrentals.co.uk
0808 196 9493

Inspections
inspections@sunbeltrentals.co.uk
03301757308

www.sunbeltrentals.co.uk